

LEAKAGE CURRENT TESTER

GLC-9000

USER MANUAL

GWINSTEK PART NO. : 82LC-90000EB1



ISO-9001 CERTIFIED MANUFACTURER

GW INSTEK

This manual contains proprietary information, which is protected by copyright. All rights are reserved. No part of this manual may be photocopied, reproduced or translated to another language without prior written consent of Good Will Corporation.

The information in this manual was correct at the time of printing. However, Good Will continues to improve its products and therefore reserves the right to change the specifications, equipment, and maintenance procedures at any time without notice.

Good Will Instrument Co., Ltd.
No. 7-1, Jhongsing Rd., Tucheng Dist., New Taipei City 236, Taiwan.

Table of Contents

SAFETY INSTRUCTIONS.....	7
Safety Symbols	7
Safety Guidelines.....	8
Power cord for the United Kingdom.....	11
OVERVIEW.....	13
Introduction	13
Leakage Current Modes	14
Measurement Principles	15
Measuring Devices.....	16
Key Features	19
Basic Theory.....	22
Leakage Current Modes	24
Leakage Current Modes	29
Measurement Flow Chart	30
Front Panel.....	31
Rear Panel	33
Touch Screen Basics	35
GETTING STARTED	37
Preparation	37
Power and Probe Connection.....	38
Power Up.....	41
Shut Down	42
OPERATION	43
Measurement Terminals	43
Non-medical Network (General Electrical Appliance)	43
Medical Equipment.....	44
Earth Leakage Current	44
Enclosure Leakage Current	46
Enclosure to Enclosure Leakage Current.....	48

Enclosure and Line Leakage Current.....	50
Patient Auxiliary Current.....	52
Patient Leakage Current I	53
Patient Leakage Current II	55
Patient Leakage Current III	56

MEASUREMENT 59

Interface	59
Selecting the Safety Class/ Grounding Class	63
Selecting a Measuring Network	64
Selecting a Measurement Mode	67
Selecting Measurement Parameters	68
Setting the Limits.....	68
Auto/Manual Measurement Functions.....	69
Setting Leakage current type	72
Setting the Range.....	73
Saving Measurement Results.....	75

SAVE/RECALL FEATURES..... 77

Save Settings	77
Recall Panel Settings or Data.....	80

USB Storage 85

Connection and Navigation	85
Copy files to USB	87
Firmware Update	88
Save a Screen Image.....	89

SYSTEM SETTINGS 91

Alarm/Tone Settings	92
Date and Time Settings	93
Language Selection	94
System Self Test	95
LCD/Touch Screen Settings	96
EUT Voltage and Current Check	98
Interface	99

Voltage Measurement.....	101
Initialize Menu	104
Version and Serial Number.....	107
EUT Outlet Settings	107
REMOTE CONTROL.....	109
Remote Control Settings	109
Remote Connection	110
Command Syntax.....	112
Command List.....	116
Measurement Network Commands	116
Measuring Equipment Configuration Commands.....	116
Measurement Mode Commands.....	116
Measurement Commands	116
Measurement Items.....	117
Manual Measurement Commands.....	117
Automatic Measurement Commands	117
Measurement Command.....	117
Measurement Data Commands	118
Save Data Commands.....	118
System Setup Commands.....	118
System Related Commands.....	119
RS232 Interface Commands	119
IEEE488.2 Interface Commands	119
Commands	120
Measurement Network Commands	120
Measuring Equipment Configuration Commands.....	121
Measurement Mode Command	122
Measurement Commands	123
Measurement Items.....	124
Manual Measurement Commands.....	127
Automatic Measurement Commands	132
Measurement Command.....	134
Measurement Data Command	135
Save Data Command	136
System Setup Command	139
System Related Commands.....	149
RS232 Interface Command	151
SCPI Status Registers	152
Event Registers.....	153
Enable Registers	153

Status Byte Register..... 154

Standard Event Register 156

Status Byte Register Command..... 157

Standard Event Register Commands 158

Other Status Register Commands..... 159

Errors 160

Command Errors 160

Execution Errors 162

Device Specific Errors 162

EXTERNAL I/O 163

Features 163

Cautions 163

I/O Definition..... 164

Connection 166

Electrical Characteristics 167

Input Signals 167

Output signal 167

Internal Power Supply..... 167

Internal Circuit Configuration 168

Timing Description..... 169

FAQ 171

APPENDIX 173

Measurement Functions 173

Specifications 175

Accessories 176

Measurement Network (MD) 177

Fuse Replacement 179

Battery Replacement..... 180

Declaration of Conformity 181

INDEX 183

S SAFETY INSTRUCTIONS

This chapter contains important safety instructions that you must follow when operating or storing a GLC-9000 series current leakage tester. Following these instructions will ensure your safety and keep the instrument in the best possible condition.

Safety Symbols

These safety symbols may appear in this manual or on the instrument.



WARNING

Warning: Identifies conditions or practices that could result in injury or loss of life.



CAUTION

Caution: Identifies conditions or practices that could result in damage to the instrument or to other properties.



DANGER High Voltage



Attention Refer to the Manual



Protective Conductor Terminal



Earth (ground) Terminal



Do not dispose electronic equipment as unsorted municipal waste. Please use a separate collection facility or contact the supplier from which this instrument was purchased.

Safety Guidelines

General Guideline



CAUTION

- Do not place any heavy object on the instrument.
- Avoid severe impact or rough handling that leads to damaging the instrument.
- Do not discharge static electricity to the instrument.
- Do not block or obstruct the cooling fan vent opening.
- Do not perform measurement at circuits directly connected to Mains (Note below).
- Do not disassemble the instrument unless you are qualified as service personnel.

(Measurement categories) EN 61010-1:2001 specifies the measurement categories and their requirements as follows. the GLC-9000 falls under category I

- Measurement category IV is for measurement performed at the source of low-voltage installation.
- Measurement category III is for measurement performed in the building installation.
- Measurement category II is for measurement performed on the circuits directly connected to the low voltage installation.
- Measurement category I is for measurements performed on circuits not directly connected to Mains.

Power Supply



WARNING

- AC Input voltage:100V/120V/220V/230V ±10%, 50/60Hz
- Connect the protective grounding conductor of the AC power cord to an earth ground, to avoid electrical shock.

Fuse



WARNING

- Fuse type: T0.4A/250V
- Make sure the correct type of fuse is installed before power up.

	<ul style="list-style-type: none"> • To ensure fire protection, replace the fuse only with the specified type and rating. • Disconnect the power cord before fuse replacement. • Make sure the cause of fuse blowout is fixed before fuse replacement.
Cleaning the GLC-9000	<ul style="list-style-type: none"> • Disconnect the power cord before cleaning. • Use a soft cloth dampened in a solution of mild detergent and water. Do not spray any liquid. • Do not use chemical or cleaner containing harsh material such as benzene, toluene, xylene, and acetone.
Operation Environment	<ul style="list-style-type: none"> • Location: Indoor, no direct sunlight, dust free, almost non-conductive pollution (Note below) • Relative Humidity: < 80% • Altitude: < 2000m • Temperature: 0°C to 40°C <p>(Pollution Degree) EN 61010-1:2001 specifies the pollution degrees and their requirements as follows. The GLC-9000 falls under degree 2.</p> <p>Pollution refers to “addition of foreign matter, solid, liquid, or gaseous (ionized gases), that may produce a reduction of dielectric strength or surface resistivity”.</p> <ul style="list-style-type: none"> • Pollution degree 1: No pollution or only dry, non-conductive pollution occurs. The pollution has no influence. • Pollution degree 2: Normally only non-conductive pollution occurs. Occasionally, however, a temporary conductivity caused by condensation must be expected. • Pollution degree 3: Conductive pollution occurs, or dry, non-conductive pollution occurs which becomes conductive due to condensation which is expected. In such conditions, equipment is normally protected against exposure to direct sunlight, precipitation, and full wind pressure, but neither temperature nor humidity is controlled.
Storage environment	<ul style="list-style-type: none"> • Location: Indoor • Relative Humidity: < 70% • Temperature: -10°C to 70°C

Disposal

Do not dispose this instrument as unsorted municipal waste. Please use a separate collection facility or contact the supplier from which this instrument was purchased. Please make sure discarded electrical waste is properly recycled to reduce environmental impact.

Power cord for the United Kingdom

When using a GLC-9000 series current leakage tester in the United Kingdom, make sure the power cord meets the following safety instructions.

NOTE: This lead/appliance must only be wired by competent persons



WARNING: THIS APPLIANCE MUST BE EARTHED

IMPORTANT: The wires in this lead are coloured in accordance with the following code:

Green/ Yellow:	Earth
Blue:	Neutral
Brown:	Live (Phase)



As the colours of the wires in main leads may not correspond with the coloured marking identified in your plug/appliance, proceed as follows:

The wire which is coloured Green & Yellow must be connected to the Earth terminal marked with either the letter E, the earth symbol \oplus or coloured Green/Green & Yellow.

The wire which is coloured Blue must be connected to the terminal which is marked with the letter N or coloured Blue or Black.

The wire which is coloured Brown must be connected to the terminal marked with the letter L or P or coloured Brown or Red.

If in doubt, consult the instructions provided with the equipment or contact the supplier.

This cable/appliance should be protected by a suitably rated and approved HBC mains fuse: refer to the rating information on the equipment and/or user instructions for details. As a guide, a cable of 0.75mm² should be protected by a 3A or 5A fuse. Larger conductors would normally require 13A types, depending on the connection method used.

Any exposed wiring from a cable, plug or connection that is engaged in a live socket is extremely hazardous. If a cable or plug is deemed hazardous, turn off the mains power and remove the cable, any fuses and fuse assemblies. All hazardous wiring must be immediately destroyed and replaced in accordance to the above standard.

O VERVIEW

This chapter describes the GLC-9000 in a nutshell, including the main features, front and rear panel description, and the power up sequence.

Introduction

Overview

Many electrical products must undergo electrical safety testing to ensure their safety. These tests include insulation resistance, withstand voltage, ground continuity and leakage current tests. These tests are complex and critical for safety standards compliance.

To comply with international standards and to ensure operator safety, leakage current tests are also performed under normal and faulty operating conditions.

Leakage current tests can be separated into 3 basic types:

- Earth Leakage current
- Enclosure Leakage current
- Patient Leakage current

The GLC-9000 complies with IEC, UL and other international electrical safety standards requiring leakage current measurement.

Leakage Current Modes

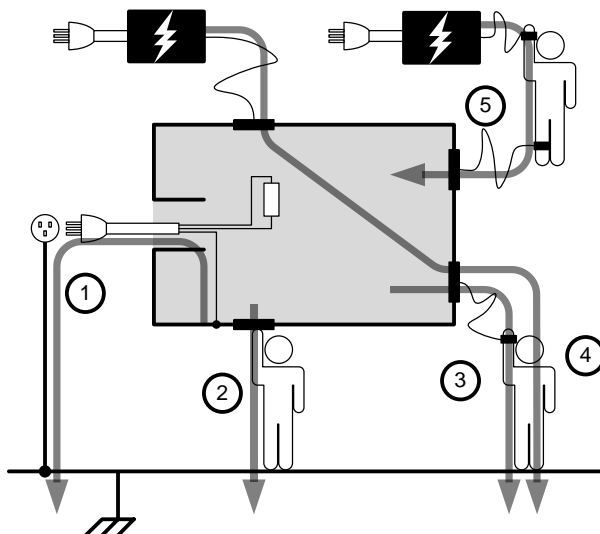

- | | |
|-------------------------------|---|
| 1. Earth Leakage Current | Refers to the current that flows through a protective grounding wire to earth. (General Electrical, Medical Equipment) |
| 2. Enclosure Leakage Current | Refers to the current that flows through a human body in contact with a device enclosure. (General Electrical, Medical Equipment) |
| 3. Patient Leakage Current I | Refers to the current that flows through a human body that is directly connected to a device. (Medical Equipment) |
| 4. Patient Leakage Current II | Refers to the current that flows through a human body that is directly connected to a device under faulty conditions. (Medical Equipment) |

5. Patient Leakage Current III	Refers to the current that flows through a human body that is directly connected to a device that malfunctions. (Medical Equipment)
6. Patient Auxiliary Current	Refers to the current that flows through a human and a device during normal operation. This is not intended to be perceptible. (Medical Equipment)

Measurement Principles

Background

Leakage current can be categorized into 3 types: Electric current that flows through the body of someone who touches the equipment, the current that flows through a protective grounding wire to earth and the current that flows through a human body connected to an applied part. When testing the leakage current of an EUT (equipment under test), testing must be performed under normal and single fault conditions.

As shown below, a number of relays are used to simulate different fault conditions. Power to the EUT is normally open and thus turning off the power disconnects one wire on the power line.

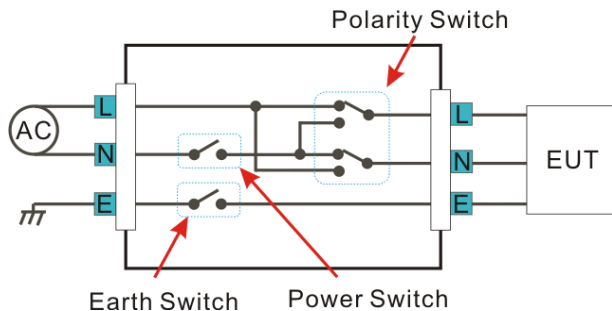

Single Fault conditions include the following:

1. Earth disconnected (excluding earth leakage current tests).
2. Disconnected neutral power line.
3. External equipment failure. (Patient leakage current II, Patient Leakage Current III).

Polarity of the power supply can also be switched to measure the leakage current under test. Thus the polarity of the power supply should also be taken into account.

Measurement Methods

The diagram below shows how the probes, MD's and power supply are connected for different leakage current tests.

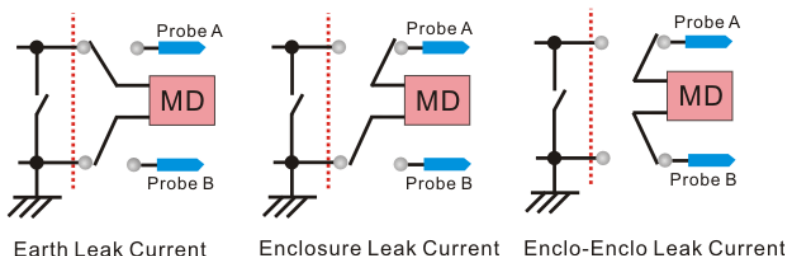

Measuring Devices

Background

Leakage current (touch current) tests that measure electrical equipment require a circuit network that can simulate the impedance of a human body. The impedance of a human body varies with the contact points, area and the path of conduction. Thus the circuit network used to simulate the impedance of a human body varies with the type of test performed. As such, the safety standards used to measure leakage current also varies greatly. The circuit networks used are known as measuring devices, or MD for short. MD

circuits are resistor-capacitor (RC) circuits. The GLC-9000 supports 9 different measuring devices.

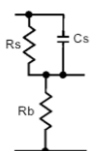
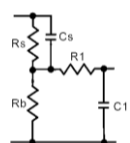
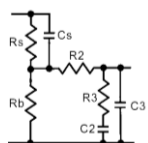
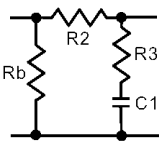
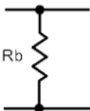
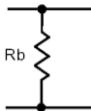
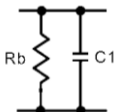
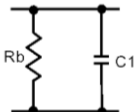
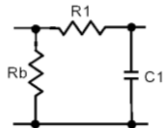
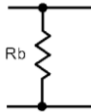
IEC60990s	MD-A	MD-B	MD-C
			
JIS Standards	MD-I		
			
General Purpose	MD-E	MD-H	
			
UL Standards	MD-D	MD-G	
			
Medical Networks	MD-F	MD-F (without RC filter)	
			



When conducting leakage current tests, please note the following:

1. Under normal operating conditions, leakage current is measured when an electrical device under test is properly insulated with earth. If the device is not properly insulated, the leakage current that is conducted through the measurement network may be invalid.
2. Leakage current tests involve high voltages. When working with high voltages, testing personnel should use proper safety precautions. All test labs should establish safety rules to cut-off power to an EUT should conditions become unsafe. Contacting any electrical appliance under test is extremely hazardous and should not be attempted.
3. The surrounding environment has an effect upon leakage current tests. Avoid high temperatures, high humidity and surface pollutants on the enclosure surface as they can all have an influence on the resulting data.

Key Features

International Standards and Regulations	<p>The GLC-9000 has nine measurement networks (Measuring Devices: MD) supporting GB/12113, IEC/UL and other international standards for electrical products:</p> <ol style="list-style-type: none"> (1) MD-A:IEC60990 (2) MD-B:IEC60990 (3) MD-C:IEC60990 (4) MD-D:UL (5) MD-E(1kΩ):-general application (6) MD-F: Medical (7) MD-G:UL (8) MD-H:(2kΩ)-general application (9) MD-I:JIS
---	---

Measurement Modes	<p>There are a number of leakage current measurement tests covering general electrical equipment and medical electrical equipment.</p> <ol style="list-style-type: none"> (1) Earth Leakage Current. (2) Leakage current from enclosure and earth. (3) Leakage current from enclosure to enclosure. (4) Leakage current from enclosure to line. (5) Patient Auxiliary Current*. (6) Patient leakage current I*. (7) Patient leakage current II*. (8) Patient leakage current III*. <p>*Tests 5,6,7,8 are applicable to medical MD-F devices.</p>
-------------------	--

Leakage Current Types	Leakage current measurement modes : DC, AC, AC+DC, AC Peak.
-----------------------	--

Measurement Range	Automatic/Manual ranges: DC/AC/AC+DC : 50uA/500uA/5mA/25mA (Range : 4uA~25mA) AC Peak : 500uA/1mA/10mA/75mA (Range : 40uA~75mA)
Operation	<ul style="list-style-type: none">• Auto/Manual/Programmable Single fault conditions and power supply polarity switch• Measurement/Delay time settings• Maximum / minimum hold• PASS/FAIL(Upper, Lower) Judgement (limits)• save and recall setup and measurement results• System clock settings• Multilanguage support• System Self test• EUT voltage/current/power consumption• High output alarm and led indicators.• Remote control interface options
Interface	With the exception of the Start, Reset and power switches, the user-interface is entirely controlled via a touch screen.
LCD	The simple, user-friendly interface is extremely intuitive with a large 5.6" color TFT screen.
EUT Test Status	The voltage, current and power consumption of the EUT can be measured.
Built-in Voltage Meter	The built in voltage meter detects 0-300V. The voltage meter is activated when the Safety Extra Low Voltage (SELV) function is on.

Memory	<ul style="list-style-type: none">• 30 sets of memory for user defined test conditions• 50 sets of standard test conditions. (e.g., IEC60990)• 100 sets of measurements can be saved/recalled
Remote Interface	There are a variety of remote control interfaces including: RS-232, USB (Host/Device), GPIB and the EXT I/O connector.
Protection	The LED warning indicator will illuminate and emit a tone by default for: <ul style="list-style-type: none">• Judgment limits. (high/low limits).• High Voltages output from the testing terminals.• Overload protection (fuse protection).• Relay protection for EUT overloads.

Basic Theory

- Overview
- GLC-9000 consists of the following blocks as illustrated in the figure below.
 - Tester and EUT power supply
 - MD (Measuring Device) circuit network
 - Current detection
 - Signal Process
 - CPU/Digital control
 - User I/O
 - Remote control interfaces

Block Diagram

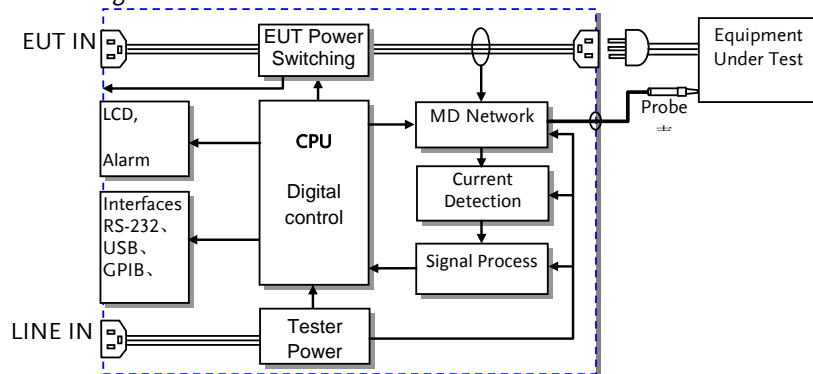

- Power
- Tester Power: Provides the power for tester circuits.
 - EUT Power: Provides an isolated power source to EUT.

EUT Power Switching	This switching matrix controls relays to alter the EUT power to simulate a number of different test conditions, such as earth open or reverse polarity, etc.
MD Network	Different MD networks represent different equivalent circuits of a human body. They are chosen according to different regulations.
Probe	Probes are used to simulate a human-touch-point on the EUT. The leakage current flows through the probe and is measured.
Current detection & signal process.	Detects and measures the different leakage current types (AC,DC,...)
CPU and digital control	CPU, digital circuits and memory.
LCD/ Alarm/Button	The touch-screen LCD, buttons and alarm are controlled by the CPU for user input and display.
Interfaces	Interfaces allow remote control via RS232, GPIB and USB.

Leakage Current Modes

Definition As illustrated below, the leakage current generated with a high voltage in an electrical appliance requires measurement under normal EUT (Equipment Under Test) conditions and under single fault conditions. Leakage current can be categorized into 3 types: Electric current that flows through the body of someone who touches the equipment, the current that flows through a protective grounding wire to earth and the current that flows through a human body connected to an applied part.

Leakage current can be composed of either conduction current that flows thru insulation resistance, or displacement current that flows thru distributed capacitance.

Earth Leakage Current

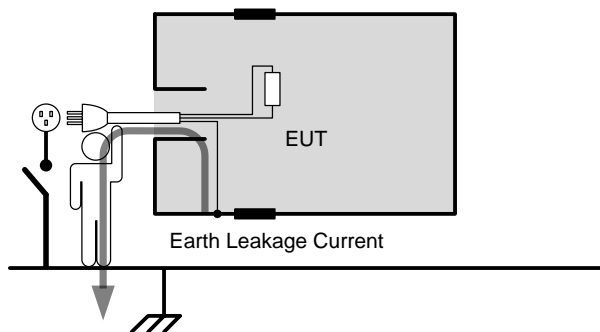

Description Earth Leakage Current Tests measure the current that flows from a protective grounding wire through a human body to earth.

Class I equipment requires the protective grounding wire to be disconnected under single fault conditions.

Leakage current can be dangerous and produce shocks over a certain limit.

Enclosure and Earth leakage current

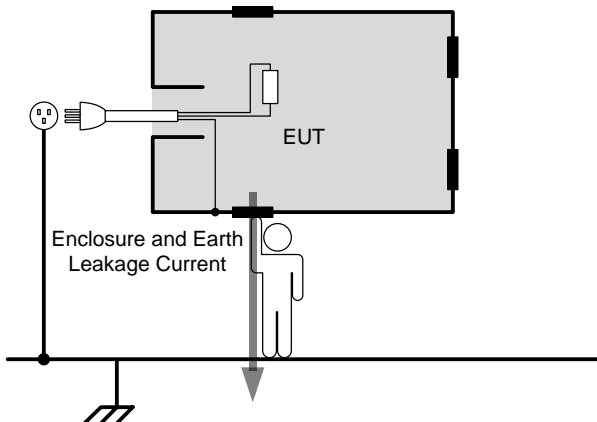

Description

During normal conditions, an operator or a patient is expected to touch the enclosure of an instrument (except for applied parts). The enclosure and earth leakage current test measures the leakage current that flows through a human body to earth when in contact with the instrument enclosure.

For class II equipment, enclosures are ungrounded, and must be tested for leakage current that flows through a human body impedance network to earth. This test also applies to Class I equipment where the enclosure is not grounded.

Enclosure and
Enclosure
Leakage Current

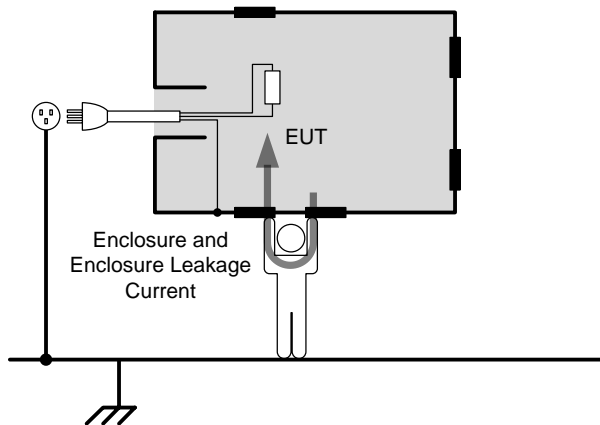

Description

Under normal or single fault conditions, the leakage current that flows through a human body from any 2 isolated parts of the enclosure.

Patient Leakage
Current I

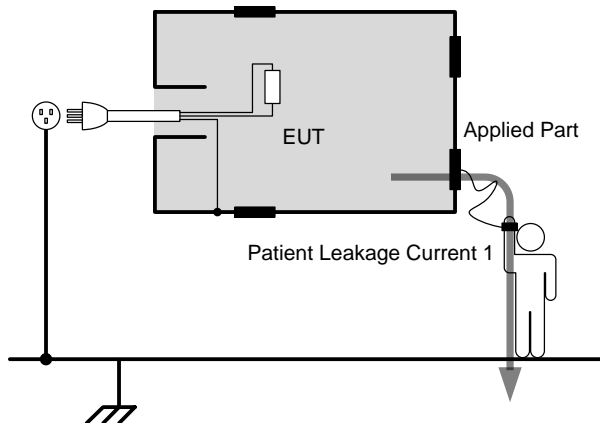

Description

Patient Leakage Current I is the leakage current that flows through a person connected to an applied part to earth.

Patient Leakage Current II

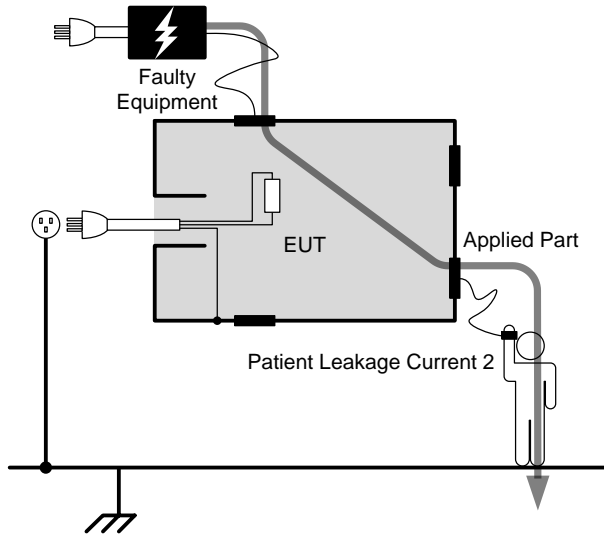

Description

Patient leakage current II refers to the current that flows from an applied part through a human body to earth. For the test it is assumed that an external I/O device that is connected to the signal input of the EUT malfunctions with an output of 110% of the rated voltage.

Patient Leakage
Current III

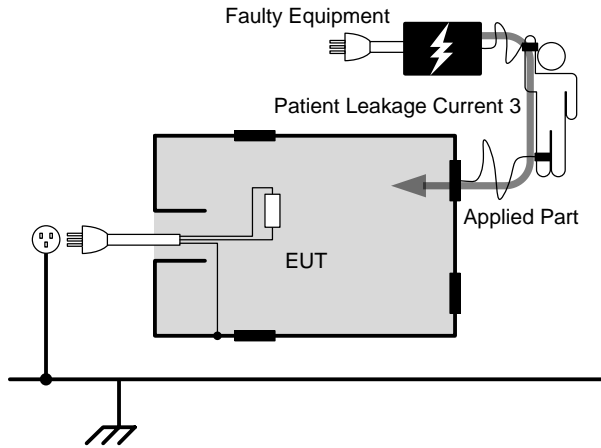

Description

Patient Leakage Current III is the leakage current that flows from a malfunctioning applied part, through a person, and through a Type F applied part.

Leakage Current Modes



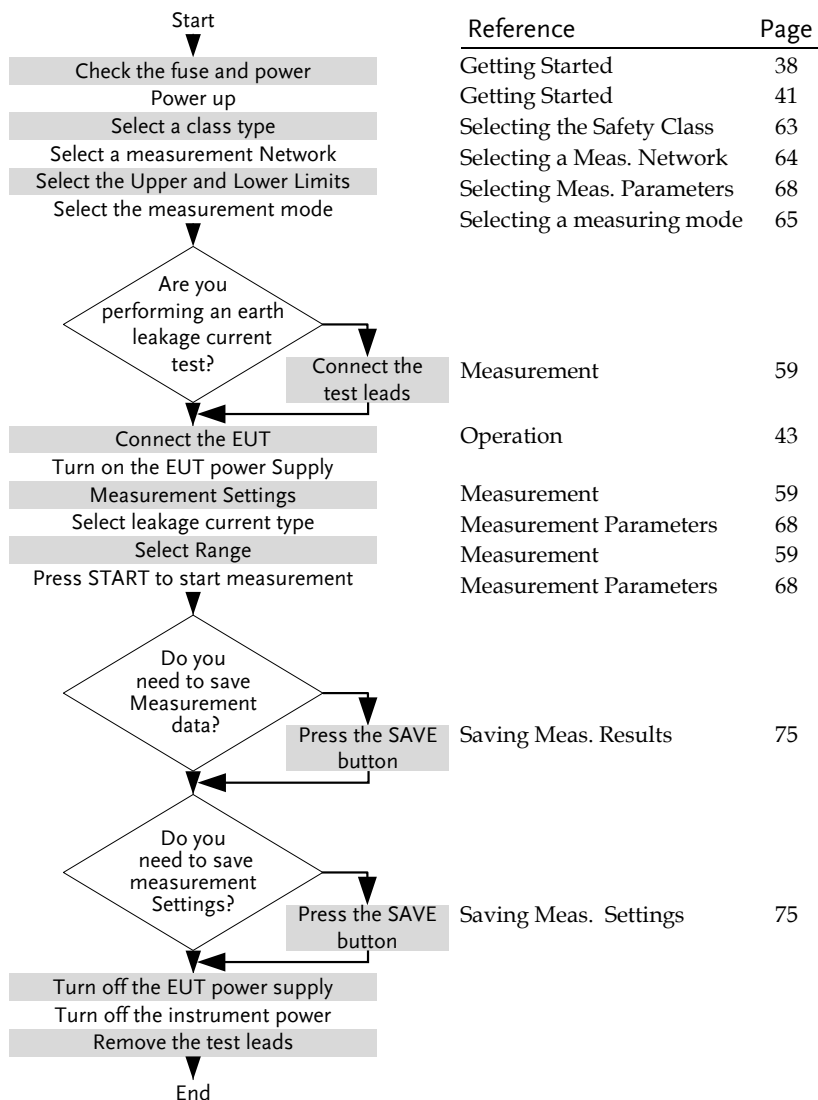

Type	Normal Condition	Single Fault	Fault Description	Notes
Earth Leakage Current	Yes	Yes	Power line disconnected.	Class 1 only
Enclosure to Earth leakage current	Yes	Yes	1. Power line disconnected.	Class 1 only*
Enclosure to Enclosure leakage current	Yes	Yes	2. Disconnected earth protection*. 3. 110% of the rated power supply voltage applied to the signal input/output parts and earth.	
Enclosure to line leakage current.	Yes	Yes		
Patient Auxiliary Current	Yes	Yes	1. Power Line disconnected.	Class 1 only*
Patient Leakage Current I	Yes	Yes	2. Earth disconnected*.	
Patient Leakage Current II	No	Yes	110% of the rated power supply voltage applied to the signal input/output parts and earth.	Type B applied part
Patient Leakage Current III	No	Yes	110% of the rated power supply voltage is applied to the F-type applied part and earth.	Type F applied part

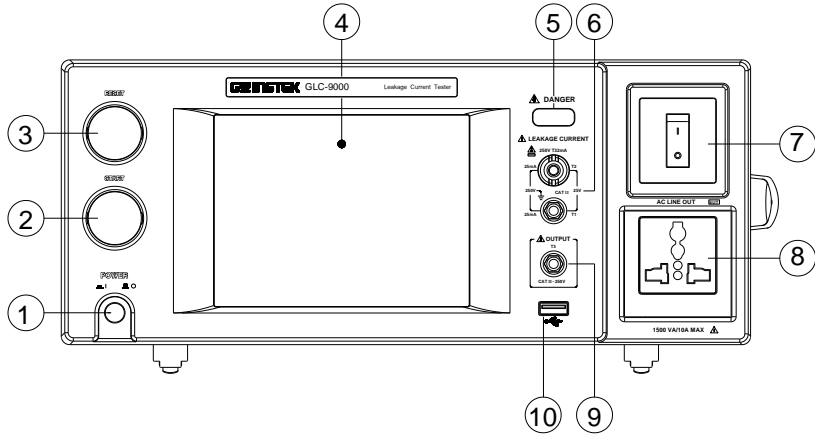

Measurement Flow Chart

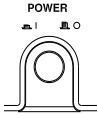

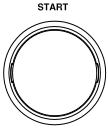
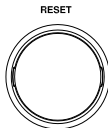
Front Panel



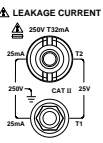
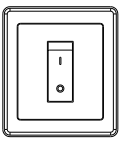
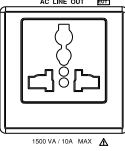

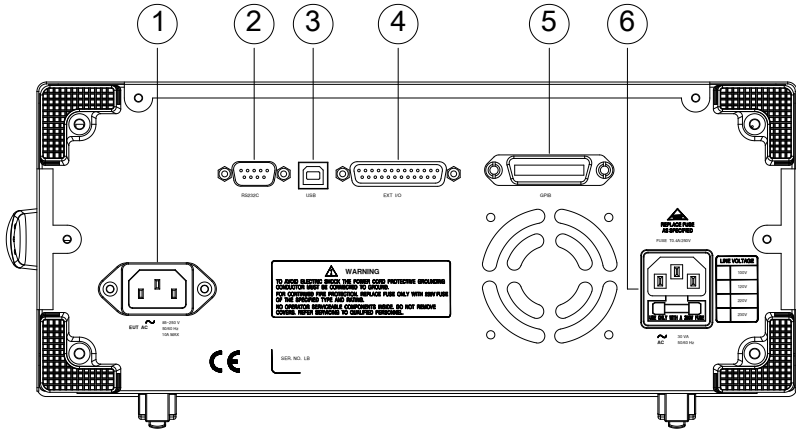

Item		Description
1. POWER		<p>The power switch turns the power on or off.</p> <p> : ON</p> <p> ○ : OFF</p>
2. START		<p>The green START button starts measurements.</p>
3. RESET		<p>The red RESET button stops measurements.</p>
4. Display		<p>5.6" inch touch screen LCD display. The touch screen display is the primary user interface.</p> <p>For more details on the LCD interface see the Measurement chapter on page 59.</p>

5. Warning Indicator		The warning indicator lights up when high voltages are produced from terminals T1, T2 or T3. The warning indicator will flash when in standby mode.
6. Measuring Terminals		Measuring Terminals T1 and T2 are used to measure leakage current. Terminal T2 has a replaceable fuse (250V, 32mA), see page 179 for details.
7. Circuit Breaker		The circuit breaker has over-current protection for the EUT rated at 15A. When testing, the warning indicator will illuminate. I: ON, normal operation O: OFF, inactive or during over-current protection.
8. EUT AC Terminal Block		Supplies AC power for the EUT. Includes automatic shut-down (circuit breaker) with over-current protection. Maximum current output 10A, maximum power output, 1500VA.
9. T3 110% Voltage Application		An isolated voltage (1:1) is output to T3 from the EUT AC IN voltage by an isolation transformer. This terminal is limited to medical networks (MD:F)
10. USB HOST		USB host terminal. For more details see the Remote chapter on page 109.

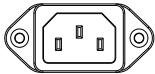
Rear Panel

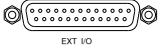

ITEM	Description
1. EUT AC IN 	EUT AC inlet. AC voltage range: 85V ~ 250V AC (Max. 264V AC) 50 ~ 60Hz 10A Max
2. RS-232 Terminal 	RS-232 Interface For more details see the Remote chapter on page 110
3. USB connector 	USB terminal for remote control. See the Remote chapter on page 110
4. EXT I/O connector 	External input/output remote control connector. For more information on the EXT I/O slave control, see page 163.
5. GPIB connector 	GPIB Interface for remote control. For details on the GPIB remote control, see the Remote chapter on page 110

6. Power Socket/
Fuse socket.



The power socket accepts AC mains power for the GLC-9000.

Power: 100V/120/220/ 230V AC

Fuse: T0.4A/250V

For more details on fuse replacement see page, 179.

Touch Screen Basics



Caution

Do not use any sharp objects or excessive pressure on the touch screen display, doing so may damage the display.

Description

The LCD touch panel is used to configure system and measurement settings. Touching an on-screen icon mimics the action of pressing a button on traditional machines. Touching an on-screen icon is referred to as pressing a key in this manual.

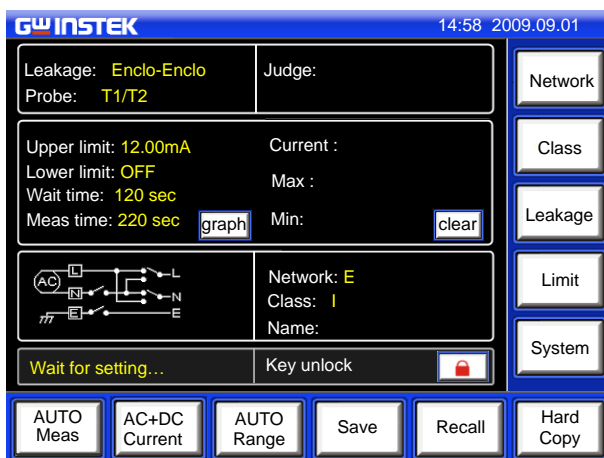

Any keys or icons that are dimmed indicate currently unavailable menus, icons or areas. This is shown in the screen capture below.



GETTING STARTED

This chapter describes the GLC-9000 in a nutshell, including the main features, front and rear panel descriptions, and the power up sequence.

Preparation

Voltage Line Selection

Before power is turned on, ensure the line voltage is correct for the environment. The line voltage is shown on the rear panel.

LINE VOLTAGE	
	100V
	120V
	220V
	230V

Voltage: 100/120/220/230V
±10% Frequency: 50~60Hz



Warning

Ensure a three pronged grounded power socket is used.

Fuse

Ensure the correct fuse is used before power up. (Fuse: T0.4A/250V)



EUT AC Line In

Before connecting power to the EUT AC Line In, confirm the EUT input power and test requirements do not exceed the EUT AC Line In requirements.

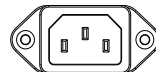

Voltage Range: 85V ~ 250V / 50 ~ 60Hz

**Caution**

* EUT : 10A(max), 1500VA(max)

**Warning****EUT Power Input wiring.**

Note the position of the live and neutral line inputs for the EUT line in and the EUT AC power block. Failing to connect the EUT input properly will affect the measurement accuracy.

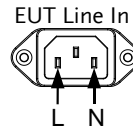

As the AC power block is designed for multiple regions, the EUT AC power block has user-defined live and neutral inputs. To configure the L & N input to your region, see page 107.

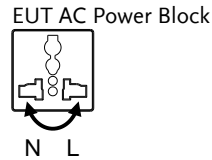

Power and Probe Connection

Mains Power

1. Ensure the power is switched off from the front panel.
2. Insert the AC mains power into the power socket on the right-hand side of the rear panel.

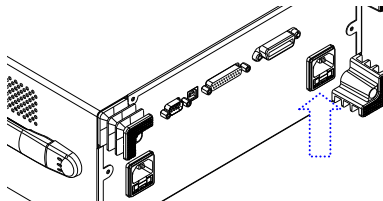

The arrow above shows the location of the AC main power socket.

EUT Power

1. Ensure the power switch is off on the front panel.

2. Insert the power cord as shown on the right into the EUT AC Line In.

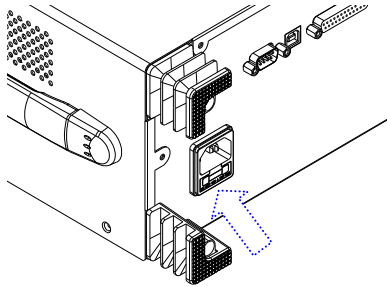

The arrow above shows the EUT AC line in socket, located on the left-hand side of the rear panel.



Caution

If network B (MD B) is selected an isolation transformer that outputs 110% of the rated voltage specified for the EUT is required. The neutral line must be grounded (from the secondary side of the transformer).

Measurement networks (MD)A, B, C all require an isolation transformer.

**T1/T2/T3
Terminals**

1. Insert the test leads to one of the terminals
2. The measuring mode determines which terminal will be used.

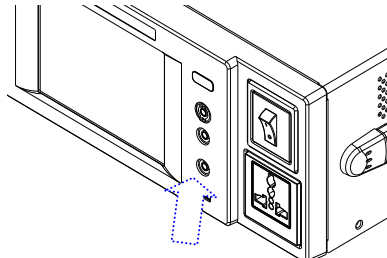

Terminals T1, T2 and T3 are shown above.



Warning: To avoid the risk of electric shock, do not touch the tips of the test leads when operating.

Foil Probe

1. The foil probe is used to measure the surface leakage current (touch current) of the EUT. Attach the probe metal-foil-side down onto the enclosure of the EUT.
2. Attach the test leads to the foil probe using alligator clips to the area on the right, as shown in the diagram

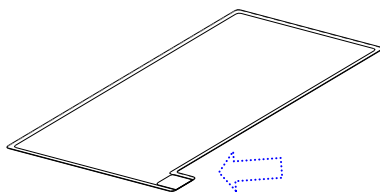

The arrow above shows the contact point for the test lead.

Alligator Clips

1. Plug a test lead into the rear panel.
2. Use an alligator clip to clip to the metal foil or to other points under test.

The arrow mark indicates the location that the test lead and alligator clips are clipped together.



Power Up

Power Up

Press the power switch to turn on the power. The system will enter the measurement interface after a quick initialization.

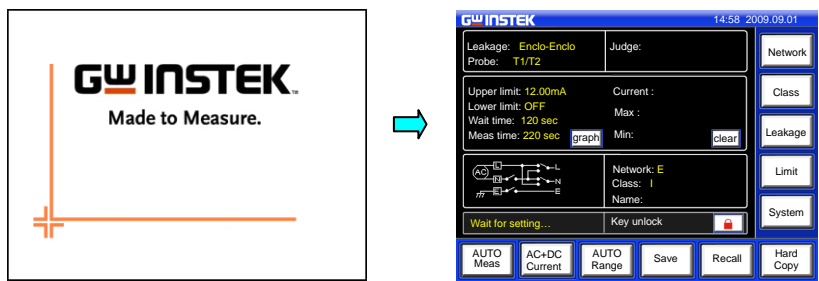
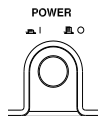

Steps

1. Turn on the power switch. Ensure the EUT power switch is off.
2. The GLC-9000 will load the last panel setting before the last shut down.
3. Wait for the machine to warm up for 30 minutes before operating.
4. Check to see if the touch screen needs to be calibrated. If so, see page 96 for details.

Shut Down

Before shutdown, ensure the EUT is shut down properly. As illustrated below, power off the circuit breaker before turning off the equipment.

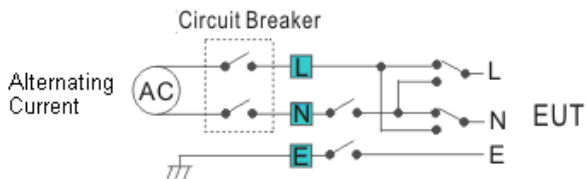

EUT Power Down Ensure the circuit breaker is turned off.

I : ON

O : OFF

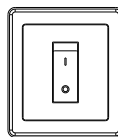

Power Down Turn off the power switch.

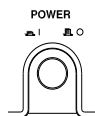

OPERATION

Measurement Terminals

When a measurement network is selected, different measuring terminals are required for each test and equipment class. The tables below list which terminals are used for with which network/test.

Non-medical Network (General Electrical Appliance)

MD-A, B, C, D, E, G, H, I

	CLASS I	CLASS II	Internal Power Supply
Earth leakage current	Not used	N/A	N/A
Enclosure and earth leakage current	T2	T2	T2
Enclosure and enclosure leakage current	T1,T2	T1,T2	T1,T2
Enclosure and line leakage current	T2	T2	N/A

Medical Equipment

MD-F

		CLASS I		CLASS II		Internal Power	
		Type B	Type F*	Type B	Type F*	Type B	Type F*
Earth leakage current		Not Used		N/A		N/A	
Enclosure and earth leakage current	Normal	T2	T2	T2	T2	T2	T2
	Fault	T2,T3	T2,T3	T2,T3	T2,T3	T2,T3	T2,T3
Enclosure and enclosure leakage current	Normal	T1,T2	T1,T2	T1,T2	T1,T2	T1,T2	T1,T2
	Fault	T1~3	T1~3	T1~3	T1~3	T1~3	T1~3
Patient auxiliary current		T1,T2	T1,T2	T1,T2	T1,T2	T1,T2	T1,T2
Patient leakage current I		T2	T2	T2	T2	T1,T2	T1,T2
Patient leakage current II		T2,T3	N/A	T2,T3	N/A	T2,T3	N/A
Patient leakage current III		N/A	T2	N/A	T2	N/A	T2

*Type F = Type BF and Type CF.

Earth Leakage Current

Network Non medical network / Medical network

Connection 1. Connect the EUT power cord to the GLC-9000 as shown in the diagram below.

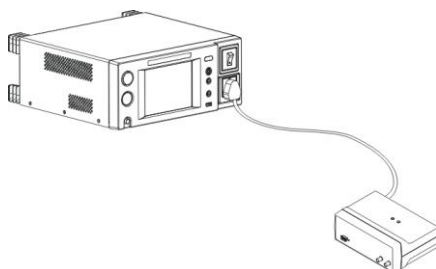

Measurement Setup Confirm all settings including MD, leakage current mode, measurement time, upper and lower limits, and other parameters.

- Panel Operation
1. Turn on the circuit breaker.
Connect the EUT power terminal.

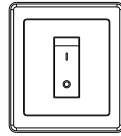

2. Press the START button to start measurements.

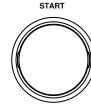

3. Press the reset button to stop measurement.



Warning

Turn the circuit breaker off before removing the EUT.

Ensure the power consumption of the EUT doesn't exceed the rated power limits.

Enclosure Leakage Current

Network	Non medical network / Medical network
---------	---------------------------------------

Connection	As illustrated, ensure that the power source and test leads are properly connected.
------------	---

Non-Medical Network	<ol style="list-style-type: none"> <li data-bbox="333 446 937 478">1. Connect the test lead to terminal T2. <li data-bbox="333 510 937 572">2. Position the test lead on an ungrounded section of the enclosure
---------------------	---

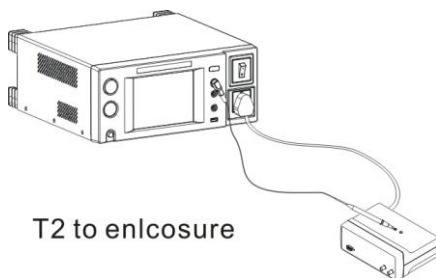

T2 to enclosure

Non-medical type (General electrical equipment)

Medical Network	<ol style="list-style-type: none"> <li data-bbox="333 965 937 1061">1. Connect a test lead to the T2 terminal and position the test lead on an ungrounded section of the enclosure. <li data-bbox="333 1093 937 1198">2. Connect a test lead to the T3 terminal and position the test lead on an ungrounded section of signal I/O on the EUT.
-----------------	---

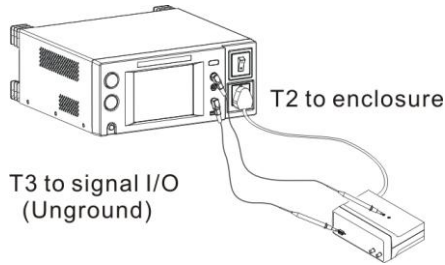

Medical type (MD-F) Requires 110% power supply voltage output.



The T3 terminal is high voltage. Avoid contact with the terminal. The T3 terminal should not be connected with an earth conductor.

Measurement Setup

Confirm all settings including MD, leakage current mode, measurement time, upper and lower limits, and other parameters.

Panel Operation

3. Turn on the circuit breaker. Connect the EUT to the power socket.

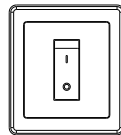

4. Press the START button to start measurements.

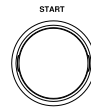

5. Press the reset button to stop measurement.

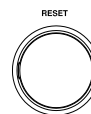

Warning

Turn the circuit breaker off before removing the EUT.

Ensure the power consumption of the EUT doesn't exceed the rated power limits.

Enclosure to Enclosure Leakage Current

Network	Non medical network / Medical network
---------	---------------------------------------

Connection	As illustrated, ensure that the power source and test leads are properly connected.
------------	---

Non-Medical network	<ol style="list-style-type: none"> 1. Connect the tests lead to terminals T1& T2. 2. Position the test leads on un-grounded sections of the enclosure.
---------------------	--

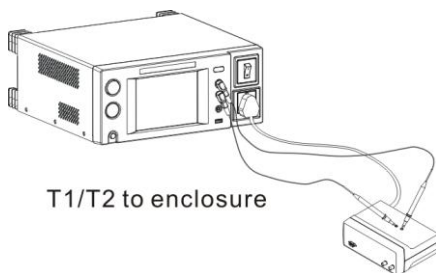

Non-medical type (General electrical equipment)

Medical Network	<ol style="list-style-type: none"> 1. Connect the test leads to the T1 & T2 terminals and position the test leads on ungrounded sections of the enclosure. 2. Connect a test lead to the T3 terminal and position the test lead on an ungrounded section of signal I/O on the EUT.
-----------------	--

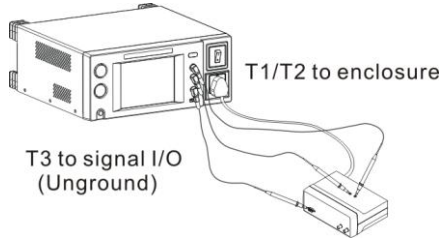

Medical type (MD-F) Requires 110% power supply voltage output.



The T3 terminal is high voltage. Avoid contact with the terminal. The T3 terminal should not be connected with an earth conductor.

Measurement Setup

Confirm all settings including MD, leakage current mode, measurement time, upper and lower limits, and other parameters.

Panel Operation

1. Turn on the circuit breaker. Connect the EUT to the power socket.

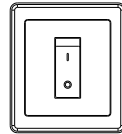

2. Press the START button to start measurements.

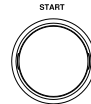

3. Press the reset button to stop measurement.

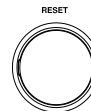

Warning

Turn the circuit breaker off before removing the EUT.

Ensure the power consumption of the EUT doesn't exceed the rated power limits.

Enclosure and Line Leakage Current

Network	Non medical network / Medical network
---------	---------------------------------------

Connection	As illustrated below, ensure that the power source and test leads are properly connected.
------------	---

Non Medical Network	<ol style="list-style-type: none"> 1. Connect the test lead to T2 terminal. Position the test lead on an ungrounded section of the enclosure.
---------------------	--

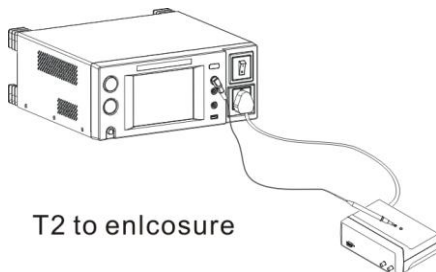

The T2 terminal is high voltage. Avoid contact with the terminal. The T2 terminal should not be connected with an earth conductor.

Measurement Setup	Confirm all settings including MD, leakage current mode, measurement time, upper and lower limits, and other parameters.
-------------------	--

Panel Operation	<ol style="list-style-type: none"> 2. Turn on the circuit breaker. Connect the EUT power terminal.
-----------------	---

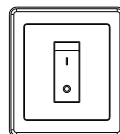

	<ol style="list-style-type: none"> 3. Press the START button to start measurements.
--	--

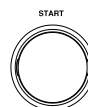

4. Press the reset button to stop measurement.



Turn the circuit breaker off before removing the EUT.

Ensure the power consumption of the EUT doesn't exceed the rated power limits.

Note

This test is equipped with ground (earth) fault detection. (A ground fault check is performed prior to measurement. Measurement is aborted if a ground fault is detected.)

Patient Auxiliary Current

Network Medical network

Connection As illustrated below, ensure that the power source and test leads are properly connected.

- Medical Network
1. Connect the test leads to the T1 and T2 terminals.
 2. Position the test leads to the applied part of the EUT.

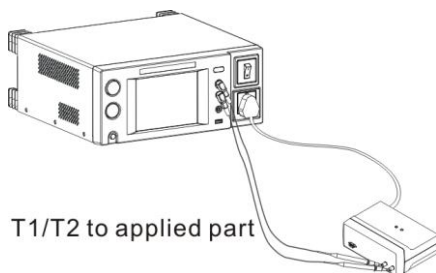

Measurement Setup Confirm all settings including MD, leakage current mode, measurement time, upper and lower limits, and other parameters.

- Panel Operation
1. Turn on the circuit breaker. Connect the EUT power terminal.

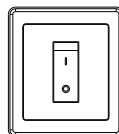

2. Press the START button to start measurements.

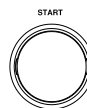

3. Press the reset button to stop measurement.

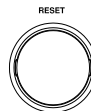

Warning

Turn the circuit breaker off before removing the EUT.

Ensure the power consumption of the EUT doesn't exceed the rated power limits.

Patient Leakage Current I

Network	Medical network, (MD-F) for the applied part. Applicable for internal power supply and Class I and Class II types.
---------	---

Connection	As illustrated, ensure that the power source and test leads are properly connected.
------------	---

- | | |
|-----------------------|--|
| Internal Power Supply | <ol style="list-style-type: none"> 1. Connect the test leads to the T1 and T2 terminals. 2. Position the T1 test lead to an ungrounded section of the enclosure. 3. Position the T2 test lead to the applied part of the EUT. |
|-----------------------|--|

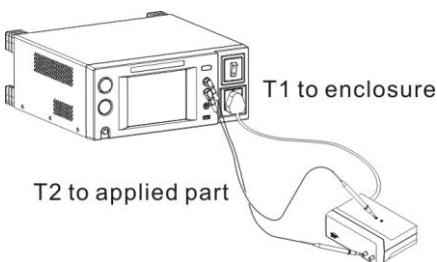

Internal power supply

- Class I/Class II 1. Position the T2 test lead to the applied part of the EUT.

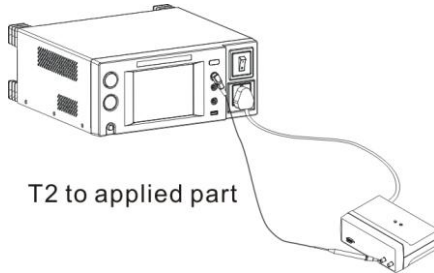

Class I and Class II

- Measurement Setup Confirm all settings including MD, leakage current mode, measurement time, upper and lower limits, and other parameters.

- Panel Operation 2. Turn on the circuit breaker.
Connect the EUT to the power socket.

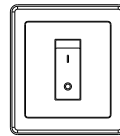

3. Press the START button to start measurements.

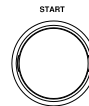

4. Press the reset button to stop measurement.

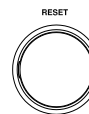

 Warning

Turn the circuit breaker off before removing the EUT.

Ensure the power consumption of the EUT doesn't exceed the rated power limits.

Patient Leakage Current II

Network For medical network circuits only (MD-F), type B only.

Connection As illustrated, ensure that the power source and test leads are properly connected.

- Type B Medical Network
1. Connect the test leads to the T2 & T3 terminals and position the T2 test lead to the applied part of the EUT.
 2. Position the T3 test lead on an ungrounded section of the signal I/O on the EUT.

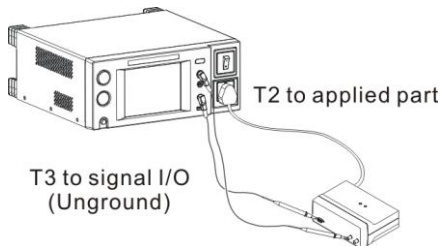

The T3 terminal is high voltage. Avoid contact with the terminal. The T3 terminal should not be connected with an earth conductor.

Measurement Setup Confirm all settings including MD, leakage current mode, measurement time, upper and lower limits, and other parameters.

- Panel Operation
3. Turn on the circuit breaker. Connect the EUT to the power socket.

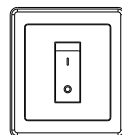

4. Press the START button to start measurements.

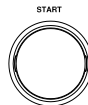

5. Press the reset button to stop measurement.

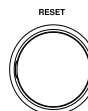

Warning

Turn the circuit breaker off before removing the EUT.

Ensure the power consumption of the EUT doesn't exceed the rated power limits.

Patient Leakage Current III

Network	For medical network circuits only (MD-F), type F only.
---------	--

Connection	As illustrated, ensure that the power source and test leads are properly connected.
------------	---

Type F Medical Network	<ol style="list-style-type: none"> 1. Connect the test lead to the T2 terminal and position the test lead to the applied part of the EUT.
------------------------	--

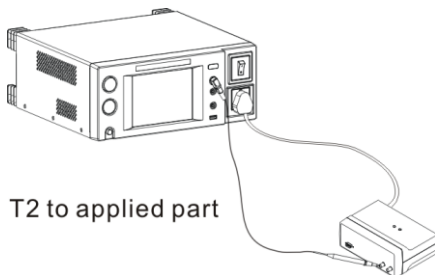



The T2 terminal is high voltage. Avoid contact with the terminal. The T2 terminal should not be connected with an earth conductor.

Measurement Setup Confirm all settings including MD, leakage current mode, measurement time, upper and lower limits, and other parameters.

Panel Operation 2. Turn on the circuit breaker.
Connect the EUT to the power socket.

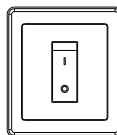

3. Press the START button to start measurements.

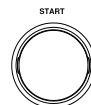

4. Press the reset button to stop measurement.

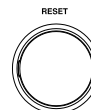

Turn the circuit breaker off before removing the EUT.

Ensure the power consumption of the EUT doesn't exceed the rated power limits.

M EASUREMENT

Interface

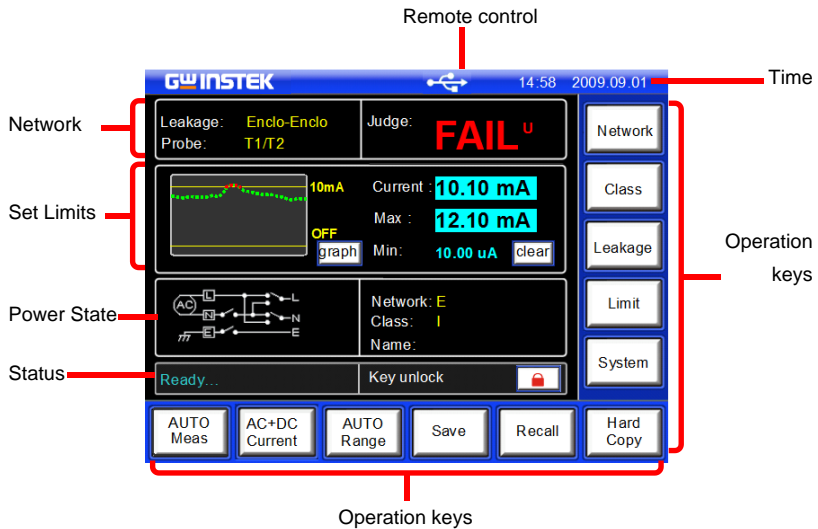

Main Display

Network

Leakage

Displays the current measuring network types (general electrical equipment and medical networks):

- Earth leakage current
- Enclosure to earth leakage current
- Enclosure to enclosure leakage current
- Enclosure to line leakage current
- Patient auxiliary leakage current

		<ul style="list-style-type: none"> • Patient leakage current I • Patient leakage current II • Patient leakage current III
	Probe	Shows the probe terminal used for the current measuring network. See page 43 for details.
	Judge:	Shows the test result judgment.

Set Limits	Upper Limit:	Displays the upper test limit.
	Lower Limit:	Displays the lower test limit
	Wait Time:	Displays the wait time before a test commences.
	Meas Time	Measurement time.

<input type="button" value="graph"/>	Toggle the Set Limit display from graphical to text mode. Graphical mode graphs the results in real-time.
<input type="button" value="text"/>	
<input type="button" value="clear"/>	

Power State	Displays the current power state settings.	
-------------	--	--

Status	Displays the status of the test. There are three status types.	
	Wait for Setting	Occurs when the instrument is powered up or when the measurement network, class or leakage current mode has changed.

Ready Occurs when the *Meas* key is pressed after *Network*, *Class* or *Leakage* is chosen.

Testing Press the *START* button whilst in Ready mode to enter Testing mode. The *RESET* option will be displayed when in Testing mode.



Indicates that the touch panel is currently unlocked. Press the *Lock* key to lock the front panel.



Indicates the front panel is locked. To unlock press and hold the unlock key for a 3 seconds.

Note: The front panel will also become locked when Start is pressed or the remote control function is used.

Remote Control

There are four types of remote control.



RS-232



GPIB



USB



EXT I/O

Time Displays the current system date and time.



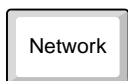



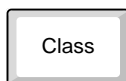

Operation Keys

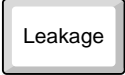

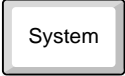
Measuring network selection

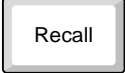

Equipment class type

	Leakage current mode selection		Set leakage current limits
	Access the system parameters		Sets the measurement mode
	Leakage current type selection		Leakage current range selection
	Save a screen image (BMP)		Save settings. Manual measurements can be saved in real-time.
	Recall settings		

Selecting the Safety Class/ Grounding Class

Operation

1. Press the *Class* button. Three options appear in the *Class setup* panel.

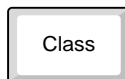

2. To select a class, press one of the *Class setup* keys.

Range

Non Medical Class I, Class II, Int power

Medical MD-F Class I, Class II, Int power, Type B, Type BF, Type CF

3. Press *Return* to return to the main screen.

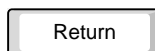

Selecting a Measuring Network

Operation

1. Press the *Network* key. Ten network choices will appear in the *Network Choice* panel.

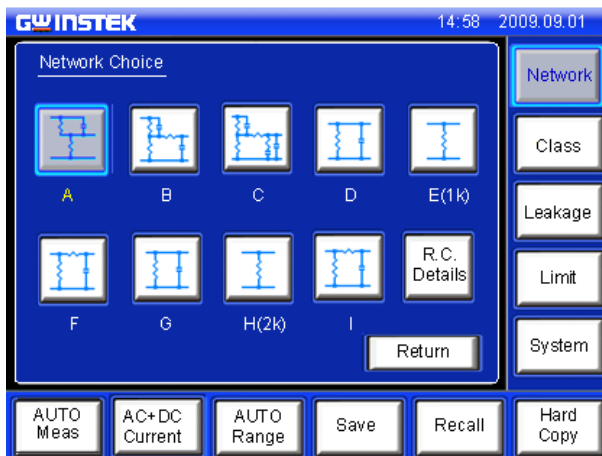
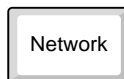

2. To choose a measuring network, press one of the network keys.

Range

Network A, B, C, D, E(1k), F, G, H(2k), I, J

3. If Network F is selected, a pop up window will ask whether you wish to use the network without an RC filter.

Choose *Yes* to use a pure 1k resistance filter, or *No* to use the RC filter option.

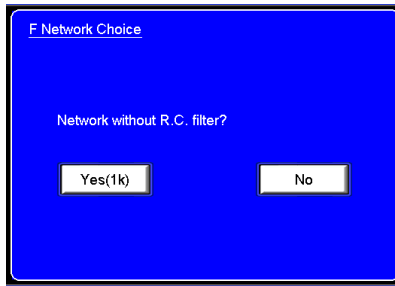

4. Press the *R.C. Details* key for details on each of the resistor capacitor networks.



5. Press *Return* to cancel selecting a measuring network and to return to the main screen.



Note

When the 1k pure resistance filter for Network F is selected, F(1k) is reflected on both the Main Display and in the panel settings, as shown below in figure A, figure B.

Figure A.

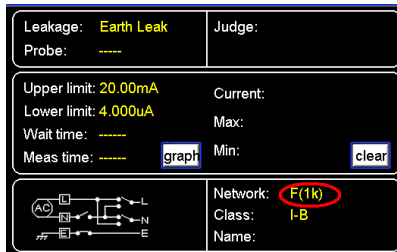

Figure B.

Panel: Panel10		<input type="button" value="Rename"/>
Network:	F(1k)	Class: I-B
Limits:	20.00mA (U)	Mode: Earth Leak
	4.000uA (L)	Range: AUTO
Meas:	MANU	Current: DC
Polarity(on): Normal		
Status(on): Normal		
Meas time: -- m -- s		
Wait time: -- m -- s		
Save OK?		<input type="button" value="Yes"/> <input type="button" value="No"/>

Selecting a Measurement Mode

Operation

1. Press the *Leakage* key to enter the Leakage Current screen.

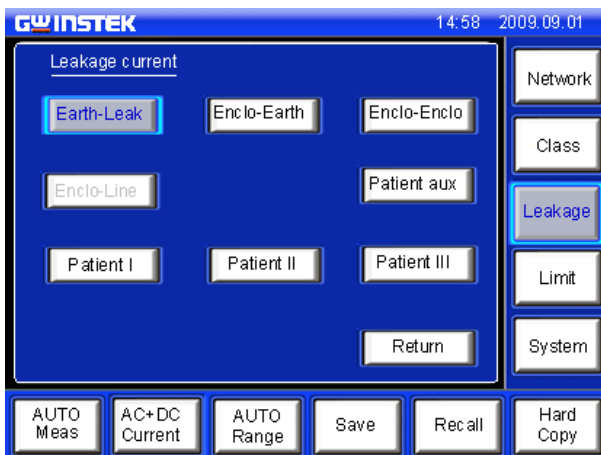
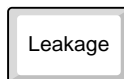

2. To choose a measurement mode, press one of the measurement mode keys.

Range

Non Medical Earth-Leak, Enclø-Earth, Enclø-Enclø, Enclø-Line

Medical MD-F Earth-Leak, Enclø-Earth, Enclø-Enclø, Enclø-Line, Patient I, Patient II, Patient III, Patient aux,

3. Press *Return* to cancel selecting a measuring mode and to return to the main screen.

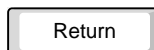

Selecting Measurement Parameters

Before measurement parameters can be set, the network model, grounding class and measurement mode need to be configured.

Setting the Limits

Operation

- To set the Upper and lower limits, press the *Limit* key to enter the Current limit setup.

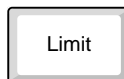

- To choose a limit, press on the *Upper* or *Lower* key.



- Toggle the corresponding *ON/OFF* key to on.

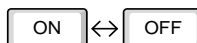

- Enter a limit using the keypad.

3.145mA

Range 4.000uA ~ 25.00mA

5. Press *Return* to go back to the previous menu.

Note The lower current limit cannot be set for less than 4uA.

Auto/Manual Measurement Functions

Background The *Meas* key is used to configure either manual or automatic measurements.

- Operation 1. To set measurement functions, press the *Meas* measurement key.

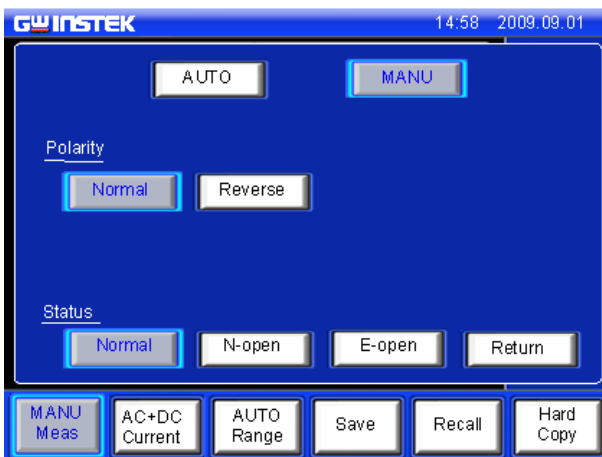

2. Choose *AUTO* or *MANU* mode. OR

Manual Mode

1. Choose a Polarity.

Range

Non-Medical Live, Neutral
(MD-B)

Medical Normal, Reverse

2. Choose T3-Out.

Range

Medical (MD- 110%N, 110%R*
F)

Other N/A

3. Choose the line Status.

Range

Non-Medical Normal, E-open, N-open

Medical N/A

* 110% voltage application. N= normal,
R=reverse phase

4. Press Return to exit to the previous menu.

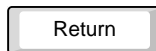

Auto Mode

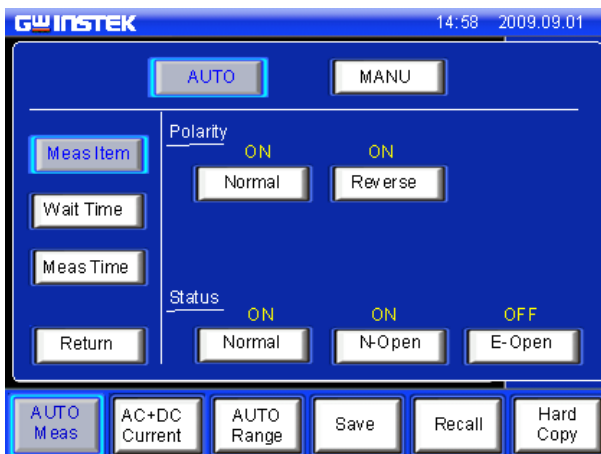

1. Choose *Meas Item*.

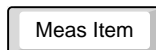

2. Select *Polarity* and line *Status* parameters.

Range

Polarity	Normal, Reverse
T3-Out	110%N (100% voltage, normal connection, 110%R (110% voltage, reverse polarity)
Status	Normal, E-open, N-open

3. Choose *Wait Time*.



4. Use the arrow keys and *sec* and *min* keys to set the delay time.

3 minutes



5. Choose *MeasTime*.



6. Use the arrow keys and *sec* and *min* keys to set the delay time.

3 seconds



7. Press Return to exit from the Auto Meas menu.

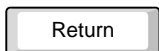

Setting Leakage current type

Operation

1. To set the leakage current type, press the *Current* key.

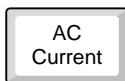

2. Choose the *Current Type*.

Range DC, AC, AC+DC, ACpeak

3. Press *Return* to go back to the previous menu.

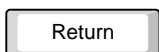

Setting the Range

Operation

1. To set the range, press the *Range* key.

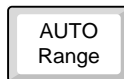

2. To set the range to automatic, press *Auto*.



3. To set the hold range, press *HOLD* followed by a range.



Range

DC, AC, 25.00 mA, 5.00mA, 500.0uA,
AC+DC 50.00uA

ACpeak 75.0 mA, 10.00mA, 1.000mA,
500.0uA

4. Press *Return* to go back to the main menu.

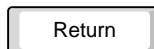



Note

The leakage current range depends on the measuring network used. The table below shows the maximum and minimum values of each range for each network type.

MD A~F,I

AC, DC, AC+DC	Range	25.00mA	5.000mA	500.0uA	50.00uA
	Maximum	25.00mA	5.000mA	500.0uA	50.00uA
	Minimum	4.00mA	0.400mA	40.00uA	4.00uA
AC Peak	Range	75.0mA	10.00mA	1.000mA	500.0uA
	Maximum	75.0mA	10.00mA	1.000mA	500.0uA
	Minimum	8.0mA	0.80mA	0.100mA	40.0uA

MD G

AC, DC, AC+DC	Range	25.00mA	5.000mA	500.0uA	50.00uA
	Maximum	16.00mA	3.300mA	330.0uA	33.00uA
	Minimum	3.00mA	0.300mA	30.00uA	4.00uA
AC Peak	Range	75.0mA	10.00mA	1.000mA	500.0uA
	Maximum	50.0mA	6.60mA	0.660mA	330.0uA
	Minimum	6.0mA	0.60mA	0.070mA	30.0uA

MD H

AC, DC, AC+DC	Range	25.00mA	5.000mA	500.0uA	50.00uA
	Maximum	12.50mA	2.500mA	250.0uA	25.00uA
	Minimum	2.00mA	0.200mA	20.0uA	4.00uA
AC Peak	Range	75.0mA	10.00mA	1.000mA	500.0uA
	Maximum	37.5mA	5.00mA	0.500mA	250.0uA
	Minimum	4.0mA	0.40mA	0.050mA	20.0uA

Saving Measurement Results

Background

When a measurement has completed, all results will be displayed on the screen, as shown below.

There are a number of options.

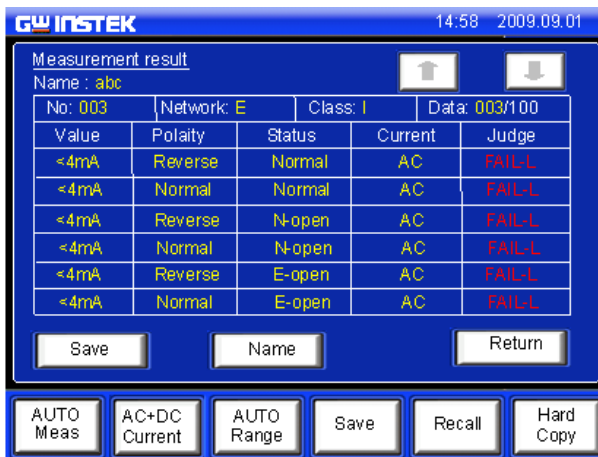

Operation

1. Use the Up and Down arrow keys to scroll through the results.



2. Press *Save* to save the on-screen results.



3. Press *Name* to the name the save file name.

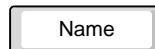

4. Use the on-screen keyboard to enter a file name.

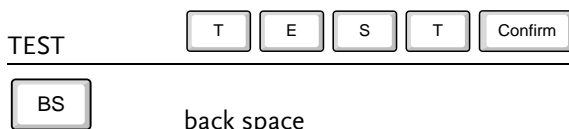

ABC

Enter key pad



123

Enter number pad



- 5. Press *Return* to return to the previous menu.

Return

SAVE/RECALL FEATURES

Save Settings

Background The GLC-9000 can save panel settings into internal memory.

The Panel settings save the following information:

- Measuring network
- Class
- Measurement Mode
- Upper and Lower Limits
- Measurement Settings (Polarity, Power line state)
- Delay time, Measurement time
- Stores the filename (in the save number)

In manual measurement, results are also saved.

Internal memory has 80 sets of memory for panel settings. However, only the first 30 sets of memory are user-configurable. The last 50 contain IEC standard test settings and can only be recalled.

For saving measurement results, see page 75.

Operation

1. To enter the *Save Panel*, press the *Save* key.



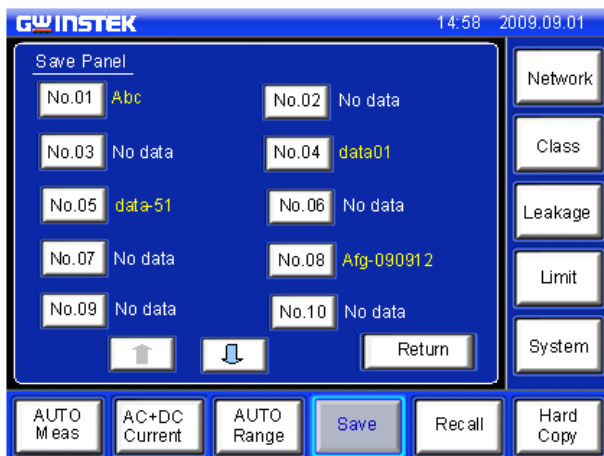

2. Use the up and down arrows to scroll each page of files.



3. Choose a save file to bring up the save file options.



4. To create or name the file, press *Rename*.

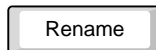

5. Use the on-screen keyboard to enter a file name.

TEST

Back space

Enter key pad

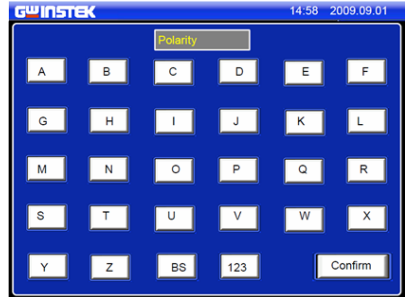

Enter number pad



6. Press *Yes* to save the file.

7. Press *No* to cancel saving a file and return to the previous screen.

8. Press *Return* to return to the previous menu.

Recall Panel Settings or Data

Background The *Recall* menu is divided into Recall Panel (settings) and Recall Data.

Recall Panel will recall the panel settings, whilst *Recall Data* will recall the results data.

There a total of 80 panel settings.

The Panel settings recall the following information:

- Measuring network
- Class
- Measurement Mode
- Upper and Lower Limits
- Measurement Settings (Polarity, Power line state)
- Delay time, Measurement time.
- Recalls the filename (in the save number)

Up to 100 measurement results (data) can be recalled.

Operation 1. To enter the *Recall Panel* menu, press the *Recall* key.

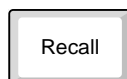

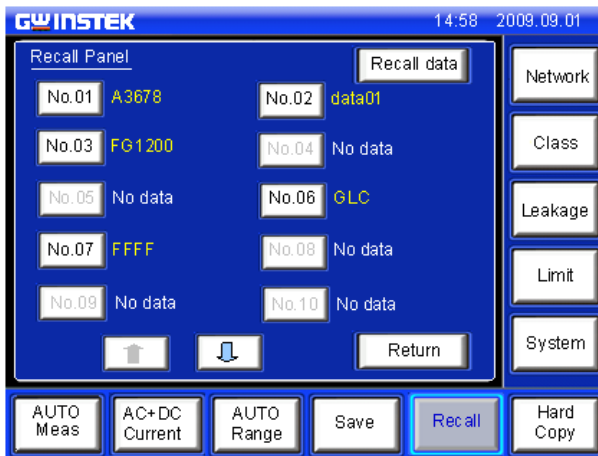

Recall Panel

1. Use the up and down arrows to scroll through each page of saved files.
2. To recall a panel setting, choose a file to recall.



The file's panel settings will be displayed on the screen.

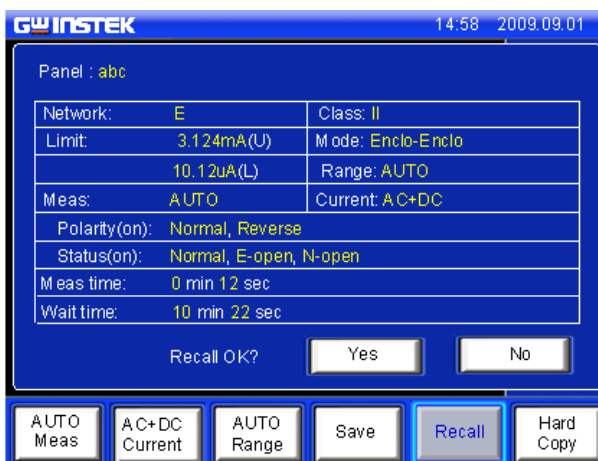

3. Press *Yes* to recall the settings. The settings will be displayed on the main display.

4. Press *No* to cancel recalling the settings and return to the previous screen.

Recall Data

1. To recall data, press the *Recall Data* key from the *Recall Panel*.

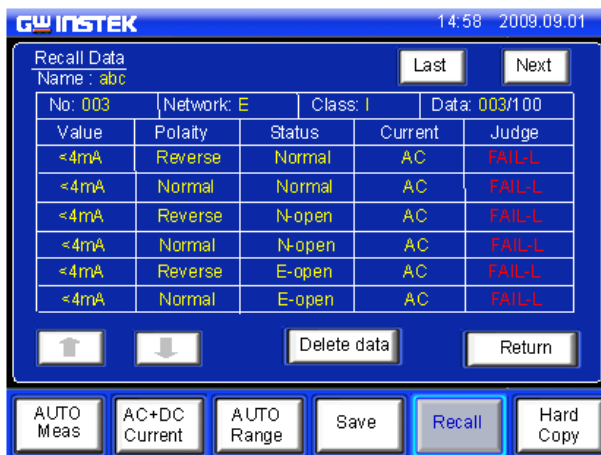

Up to 100 results can be recalled.

2. Use the *Last* and *Next* keys to navigate through each save file.

3. Use the arrow keys to highlight and scroll through data.

4. To delete highlighted data, use the *Delete Data* key.
-

A rectangular button with a thin border and a light gray background, containing the text "Delete data" in a sans-serif font.

5. Press *Return* to return to the previous menu.

A rectangular button with a thin border and a light gray background, containing the text "Return" in a sans-serif font.

U SB Storage

Connection and Navigation

Background	The USB port is used to copy files (panel settings, measurement results, screen images) and for performing firmware updates.
------------	--

File Format	The GLC-9000 recognizes*.CSV *.BMPand *.BIN file formats.
-------------	---

File name	Only 8.3 length filenames are supported.
-----------	--

Connection	1. Insert a USB flash drive into the USB port located on the front panel.
------------	---



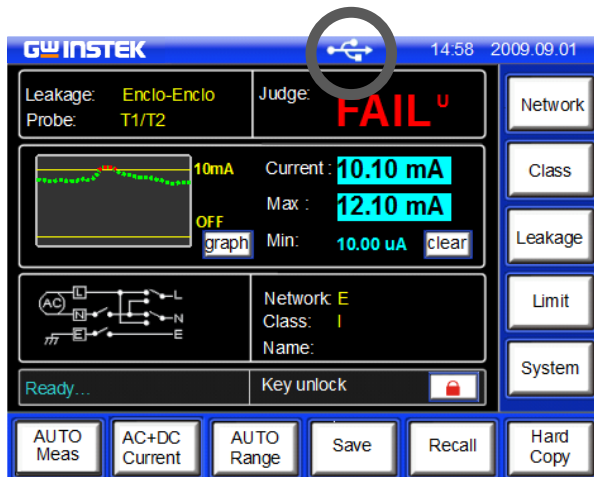



The flash drive will be automatically detected after insertion. Once detected, the USB icon will appear on the status panel.

Operation

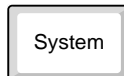
1. To access the System setup menu, press the *System* key.
2. Press *USBStorage* from the System setup menu.

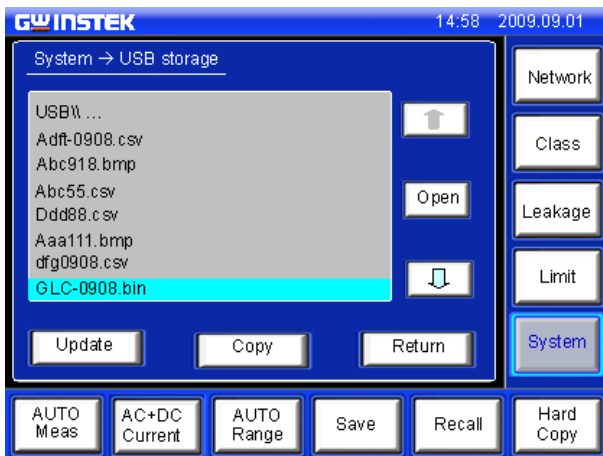



File Navigation 1. To navigate the USB file system, use the *Up* and *Down* arrow keys.  

2. Press *Open* to open a highlighted directory. 

Return 3. Press *Return* to return to the system menu. 

Copy files to USB

Background Panel settings and data can be copied to USB storage. Panel settings have the format *.CSV

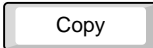
Operation 1. Press *Copy* from the USB Storage menu to enter the copy menu settings. 

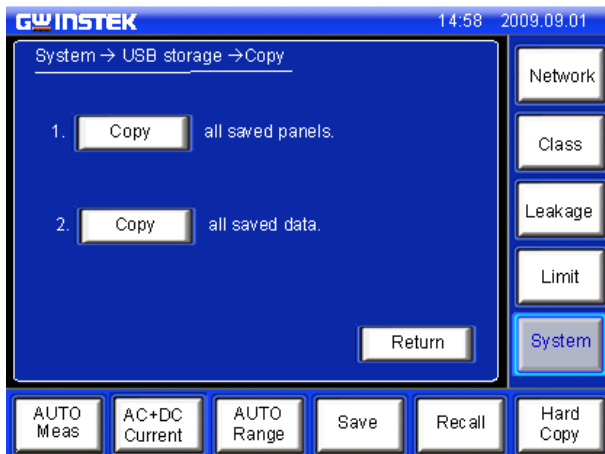

2. Choose to copy either the saved panel settings or saved data to USB memory.

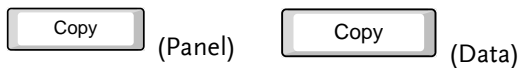

Return

3. Press *Return* to cancel copying and return to the system menu.

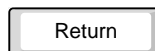

Firmware Update

Background

The firmware can be updated via the USB drive. For the latest firmware, please see your local distributor or contact GW Instek at marketing@gwinstek.com.tw

File Format

All firmware updates use a *.bin file format.

Operation

1. Highlight a firmware file (*.bin) in the USB *Storage menu* using the arrow keys.



GLC-0908.bin

2. Press the *Update* key.

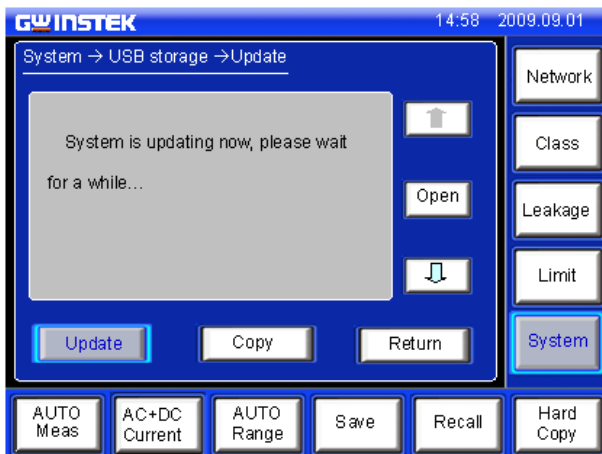
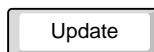

Wait while the system updates.

Save a Screen Image

Background Screen shots of the main display can be captured via the *Hardcopy* key. Each screen shot is saved as a bitmap (*.BMP) file in a directory named GLC9000.

File format *.BMP

Operation 1. Insert a USB flash drive into the USB port located on the front panel.



2. Press the *Hardcopy* key, and wait for the image to be copied to the USB flash drive.

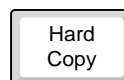

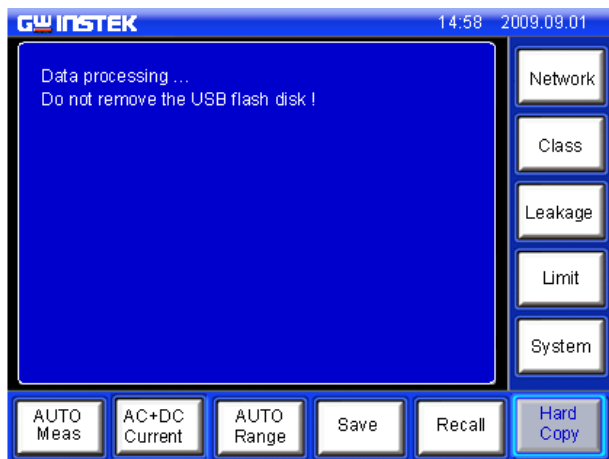

Note

If a USB disk has not been inserted, you will be prompted to insert a USB flash disk after the Hardcopy key is pressed.

S SYSTEM SETTINGS

Background The *System* key is used to access the *System setup* menu. The system setup menu can then be used to access a number of different system menus.

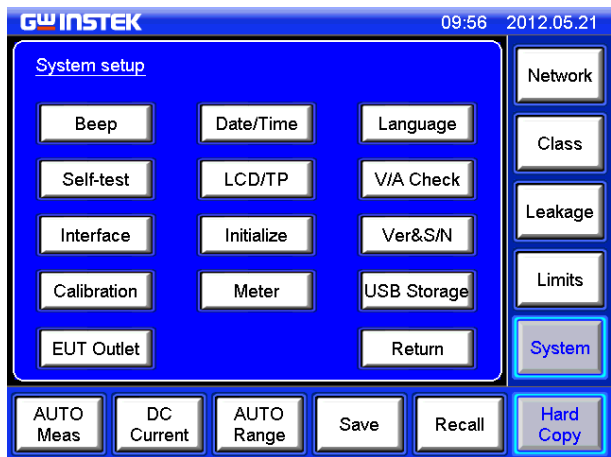

Panel Operation 1. To access the *System setup* menu, press the *System* key.

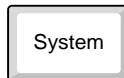

Alarm/Tone Settings

Background The *Beep* menu is used to set alarm tones for different events.

Panel Operation 1. Press *Beep* from the *System setup* menu.

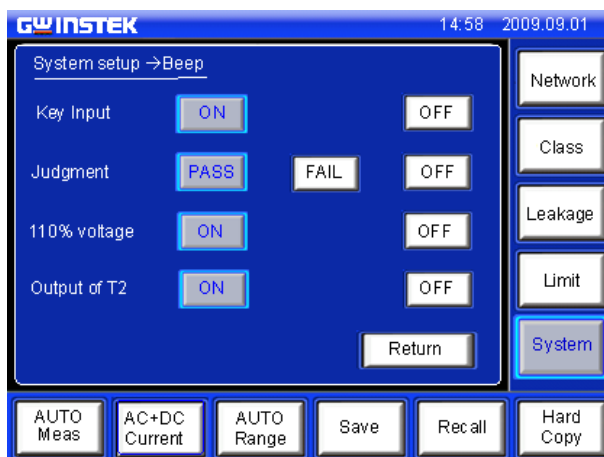

Setting an event to *ON* will allow an alarm tone to be heard when that event occurs. Selecting *PASS* or *FAIL* will produce a tone for a pass or fail judgment.

2. To turn an alarm on, set an event to *ON*, *PASS* or *FAIL*.

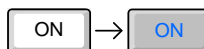

3. To turn off an alarm off, set an event to *OFF*.

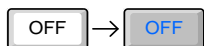

4. Press *Return* to return to the System setup menu.



Date and Time Settings

Background The Date and Time menu is used to set the time and date.

Panel Operation 1. To access the Date and Time menu press the Date&Time key.



2. Use the up and down arrow keys to set the date and time.



3. Press Return to return to the System setup menu.

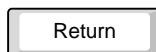

Language Selection

Background Use the *Language Selection* menu to select the language used for the user interface.

Panel Operation 1. To access the *Language Selection* menu, press the *Language* key from the *System setup* menu.

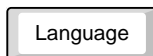

2. Choose a language.

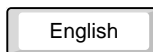

Range English, Chinese, Undefined

The undefined button can be used for additional languages (i.e Russian, Japanese, etc). Additional languages can be installed from the USB port if supported by the manufacturer.

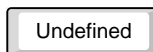

3. Press *Return* to return to the *System setup* menu.

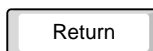

System Self Test

Background The system self-test function allows the system functions to be checked automatically.

Panel Operation 1. To access the *Self-test* menu, press the *Self-test* key from the *System setup* menu.

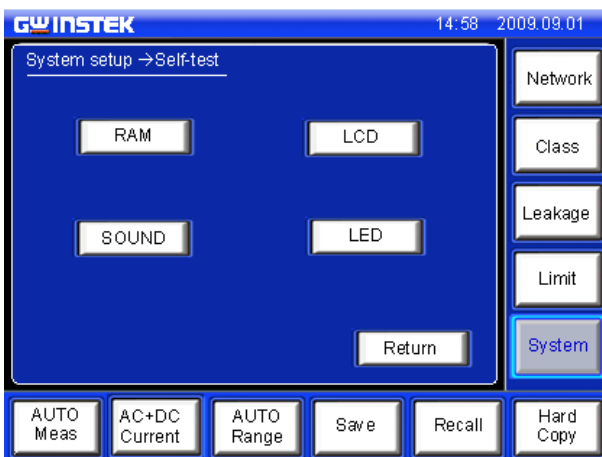
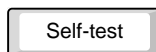

2. To perform a self test, choose any of the soft test functions (*LED, LCD, RAM, Sound*).



3. The results of the system test will be shown after the self test finishes.

Range LED, LCD, RAM, Sound

4. Press *Return* to return to the *System setup* menu.

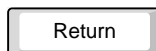

LCD/Touch Screen Settings

Background The *LCD & Touch Panel* menu adjusts the LCD backlight wait time and calibrates the touch panel.

Panel Operation 1. To access the *LCD & Touch Panel* menu, press the *LCD/TP* key from the *System setup* menu.



Back Light Setting the Backlight to ON will keep the backlight on at all times. Selecting OFF will make the back light turn off after a set Wait time.

1. To turn the backlight on continuously, press *ON*.



2. To make the backlight turnoff after a set period, press *OFF* and use the arrow keys to set a wait time.



3. Press *Return* to return to the System setup menu.

A rectangular button with a light gray background and a thin black border, containing the word "Return" in a simple sans-serif font.

-
- LCD Calibration 1. Press Calibration to enter the calibration screen.

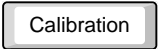
A rectangular button with a light gray background and a thin black border, containing the word "Calibration" in a simple sans-serif font.

2. Press each of the X's in the center to calibrate the LCD.

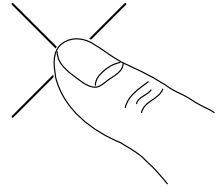

-
3. Press Cancel to cancel the calibration.

A rectangular button with a light gray background and a thin black border, containing the word "Cancel" in a simple sans-serif font.

EUT Voltage and Current Check

Background The EUT voltage and current check tests voltage, current and power consumption.

Panel Operation 1. To access the *EUT voltage & current check* menu, press the *V/A Check* key from the *System setup* menu.

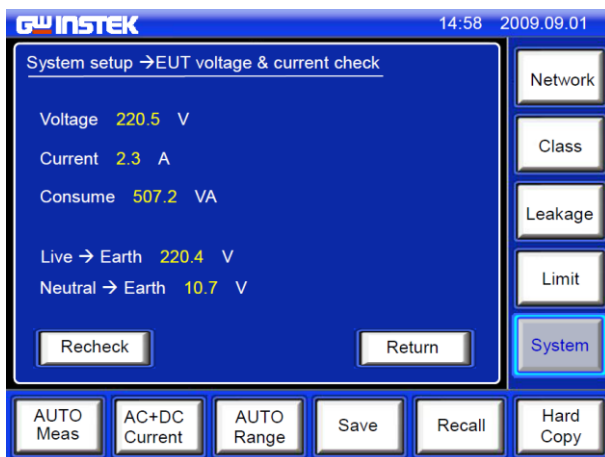
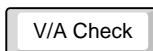

Voltage, current, power consumption and voltage between Live and Earth as well as Neutral to Earth will be displayed.

2. To perform the voltage and current check again, press *Recheck*.

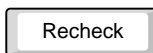

3. Press *Return* to return to the *System setup* menu.

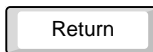

Interface

Background The Interface menu is used to select the remote control interface and interface settings. After a connection has been established, an interface icon will be shown in the LCD display.

Panel Operation 1. To access the *Interface* menu, press the *Interface* key from the *System setup* menu.

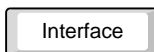

RS232, USB and GPIB can be selected from the interface menu. Each interface has a set a number of parameters and includes interface information.

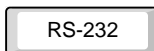

RS232 1. To set the interface to RS232, press RS-232.







2. Click the arrow and select a baud rate from the drop down list.



Range 4800~115200 baud, 8 bit data, no parity check, 1 stop bit.

- USB
- To set the interface to USB, press USB. 
 - Click the arrow and select a baud rate from the drop down list. 
-
- Range 4800~115200 baud, 8 bit data, no parity check, 1 stop bit.
-

- GPIB
- To set the interface to GPIB, press GPIB. 
 - Click the arrow keys to select a GPIB address.  
-
- Range 1~30
-

- Press *Return* to return to the *System setup* menu. 

Voltage Measurement

Background As a voltage meter, different types of voltages can be measured: AC, DC, AC+DC and AC peak. The safety extra low voltage limit can also be set from the *Meter* menu.

- Panel Operation** 1. Press the *Meter* key to access the *Voltage Meter (T1/T2)* menu.

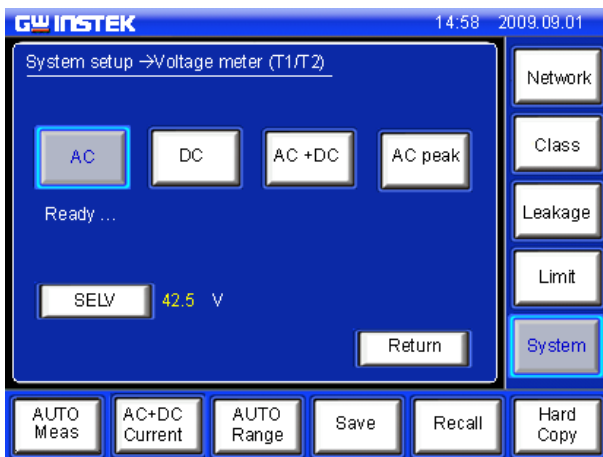
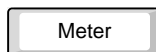

- Meter Mode** 1. Choose the current type.

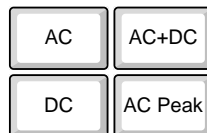

2. Press the start button to begin measurements.

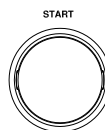

Range AC, DC, AC+DC, AC Peak

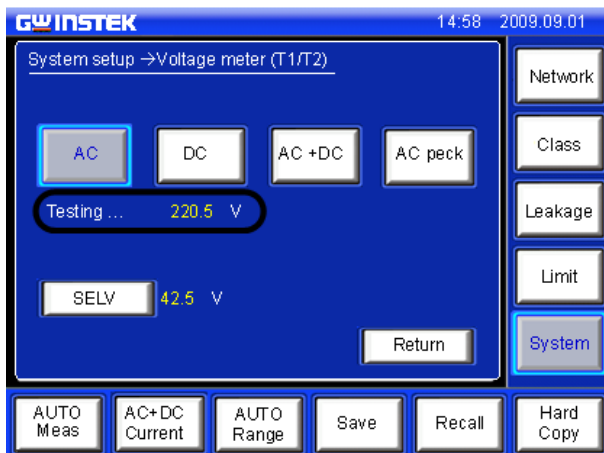

Measurements are shown in the center of the screen.

SELV

1. To set the safety extra low voltage, press the SELV key.

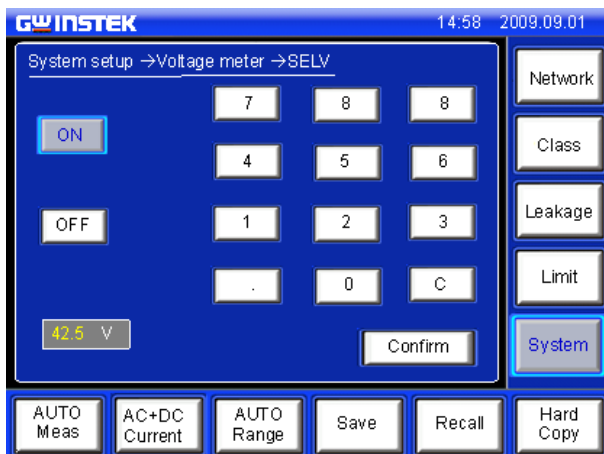
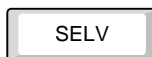

When the voltage exceeds the safety extra low voltage (SELV), the warning indicator will become illuminated and an alarm will sound. SELV can be auto configured or turned off.

2. To set the SELV use the number pad and press *Confirm*.

99 V=

3. Press *ON* to enable the SELV.

Range 0~99 volts

4. Press *OFF* to disable the SELV.

5. Press *Return* to return to the System setup menu.

Initialize Menu

Background The *Initialize* menu lets you initialize a number of settings. Saved data and panel settings can be deleted, factory settings can be restored and zero adjustments can be performed.



Note

The Zero adjustment is used to eliminate the effects of extension or adapter power cables that are used with the EUT power cable. It is only necessary for earth leakage tests.

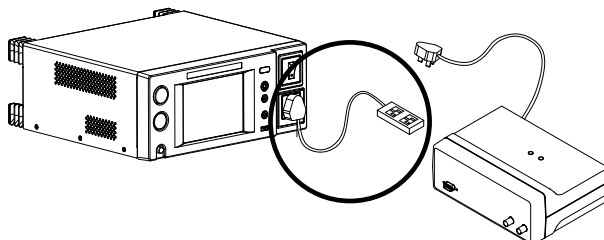

Panel Operation 1. Press the *Initialize* key to access the *Initialize* menu.

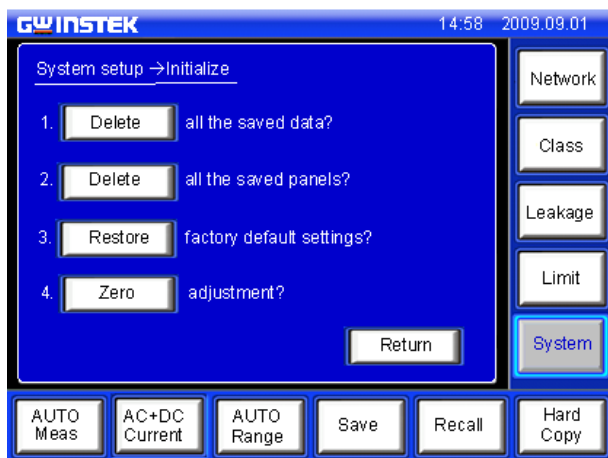
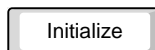

Delete Data 1. Press the 1st or 2nd *Delete* key to delete either all the saved data or all the panel settings.



Restore Default Settings 1. To restore factory default settings, press *Restore*.



2. Chose *Yes* to accept or *No* to cancel restoring the factory default settings.

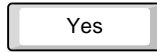

OR

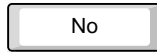

Zero Adjustment Zero Adjustment is used to compensate for extension or adapter cables that are connected to an EUT power cable for Earth (Ground) leakage tests. Zero adjustment is only applicable in AC or AC Peak modes in earth leakage mode.

Conditions	Class I	Page 63
	Earth Leak mode	Page 67
	AC or AC Peak current	Page 72

1. Ensure the EUT cable is disconnected from the extension or adapter cable that is connected to the leakage current tester.

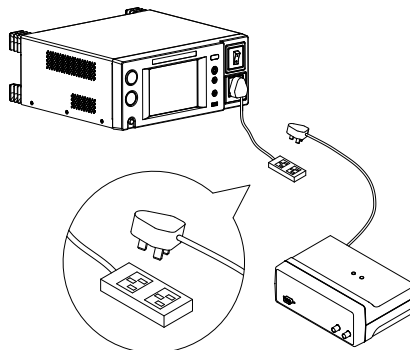

2. To perform a zero adjustment, press *Zero*.

3. Chose *Yes* to accept or *No* to cancel the Zero adjustment at the next screen.
OR

After the zero adjustment has been performed, a Z icon will be displayed on the main panel.

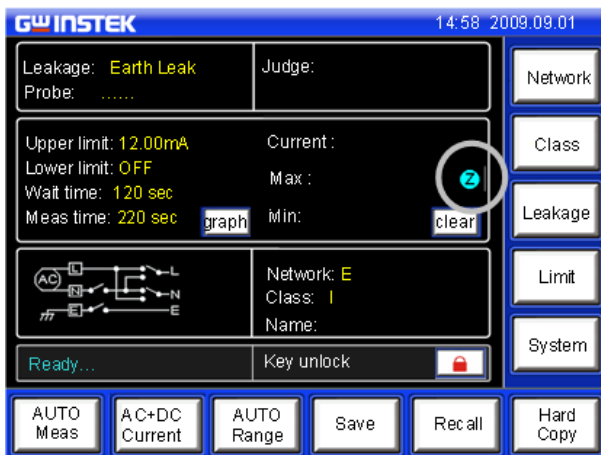

- Cancel Last Zero Adjustment
4. To remove the Zero adjustment, press *Zero* again in the Initialize menu.

 5. Chose *Yes* to confirm or *No* to not remove the zero adjustment.
OR
-
6. Press *Return* to return to the System setup menu.

Version and Serial Number

Background Used to check machine firmware version number and serial number.

- Panel Operation
1. Press the *Ver & S/N* key. The Version & S/N menu will appear.

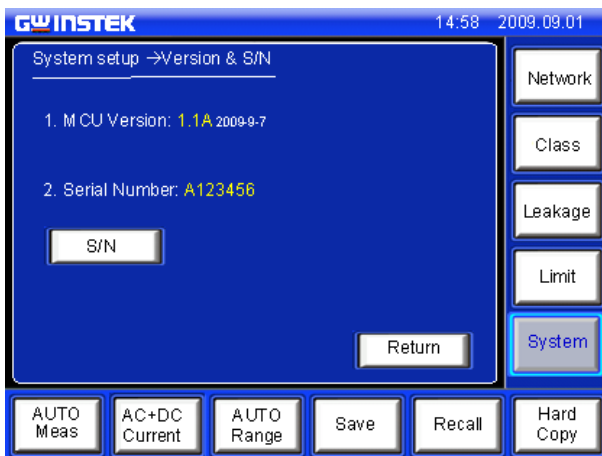
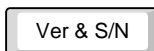

The firmware version and serial number is shown.

2. Press Return to return to the System setup menu.

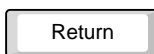

EUT Outlet Settings

Background The EUT Outlet setting is used to set which input terminals on the EUT AC block are used for live and neutral.

- Panel Operation
1. To access the *EUT Outlet* menu, press the *EU Outlet* key from the *System setup* menu.

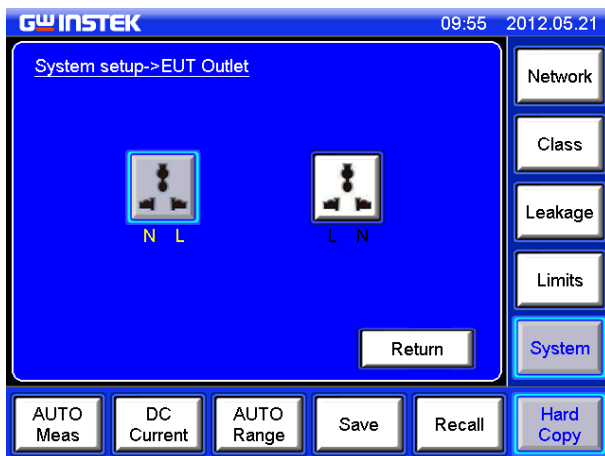
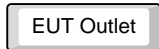

The EUT Outlet menu will allow you to select the live and neutral input terminals.

2. Select which input terminal configuration will be used for the EUT AC block.

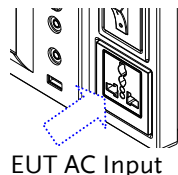

Range



3. Press *Return* to return to the *System setup* menu.

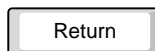

RREMOTE CONTROL

Remote Control Settings

Background Remote control can be used with the USB, RS232 or GPIB interfaces.

Interface

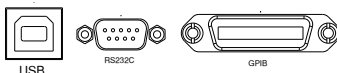

The rear panel RS-232, USB(Device), GPIB interface

COM Port Settings

Configure the PC comport setting as shown below:

- Baud rate: 4800/9600/115200. See page 99 for information on how to set the baud rate on the GLC-9000.
- Parity: None
- Data bits: 8
- Stop bits: 1
- Data overflow control: None

Note

The USB settings are configured the same as the RS232 settings.

GPIB Settings

Set the GPIB parameters as shown below:

- Address: 1~30
- Command Terminator: LF or CR+LF.

See page 99 for details on how to configure the GPIB address on the GLC-9000.

Function Test Open a terminal session, such as MTTY (Multi-threaded TTY).



Enter the following query to test the system.

* IDN?

If remote control is working correctly, the query will return the machine manufacturer, model, serial number and firmware version number.

GW INSTEK, GLC-9000, SN: xxxxxxxx, Vx.xx

Remote Connection

- Enabling Remote Connection Mode
1. Connect a USB, RS232 or GPIB cable.
 2. Send a command to the GLC-9000*. If the connection is successful, the relevant icon will appear on the LCD status bar.
 -  RS232
 -  USB
 -  GPIB
 3. When Remote control is initialized, the UI panel will be locked, as shown below.

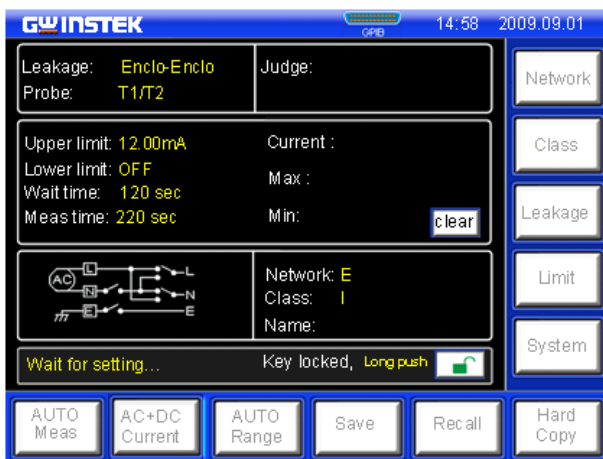

- Disabling Remote Control
1. Send the disconnect command** from the PC terminal. The status bar icon should disappear.
 2. Disconnect the interface cables from the rear panel.
 3. The front panel should now be unlocked.



Note

The USB port is hot-swappable. Any devices can be directly connected or disconnected.

*RS-232/USB connection command: any command can connect.

**RS-232/USB disconnection command: System:local

Command Syntax

The programming syntax used with the GLC-9000 conforms to IEEE488.2 and SCPI (Standard computer Programming Interface) is designed for test and measurement instruments. It is based upon ASCII instrument command codes.

SCPI command syntax is based upon a “tree” hierarchy. In this system, related commands are grouped together at a common root level. Below, the “tree” hierarchy of the CONFigure command is shown.

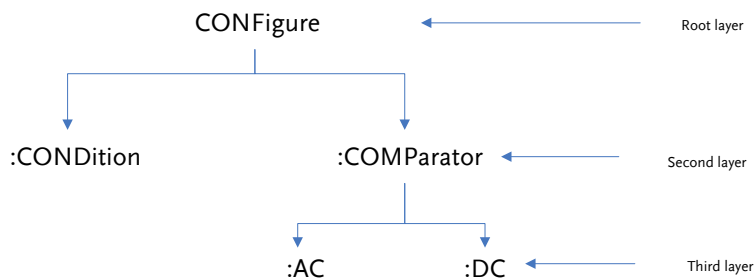

The command syntax is made up of short and long command forms. Any commands written in upper case, indicates the short command form, any command written in lower case indicates the long command form. Even though the commands are written in upper and lower case to distinguish between the command forms, either short or long command forms can be written in either upper or lower case. For example, the above syntax structure CONF and CONFIGURE are both acceptable formats, in upper or lower case letters. However, other forms of abbreviation such as CON and CONFigur are erroneous.

- Curly brackets indicate that the parameter(s) enclosed must be used.
- Vertical bars are used to separate parameters enclosed within brackets. The vertical bar indicates that only one of the enclosed

parameters can be used.

- Square brackets indicate that the data enclosed in the brackets are optional. The square brackets are not to be used when issuing a command, e.g., "CONF:COMParator 5.000E-05,20.00E-03"

Command separators

A colon (:) is used to separate a command key word from the next key word. A parameter and a command key word must be separated by inserting a space. A comma is used to separate neighboring parameters, if a command needs multiple parameters.

"CONF: COMParator 5.000E-05,20.00E-03".

A semi colon (;) can be used to concatenate two separate commands that use the same root command. For example:

"CONF:COND NORMAl; RANGe AUTO" is the same as the 2 commands below:

" CONF:COND NORMAl "

" CONF:RANGe AUTO "

Connect different sub-system commands by using colons and semi colons. For example, for the command string below, errors occur if the colon and semi colon are not used.

"CONF:COND NORMAl;;NETWork A"

Queries

Most commands can be queried by passing a Question Mark to the command, e.g., to discover the type of network used, the network command can be queried using the query command below:

" NETWork?"

SCPI Command Terminators To terminate a message, either a line feed character <LF>, EOI or line feed and carriage return <LF><CR> can be used. Here <LF> can be used as the EOI line. When a message terminator is sent to the instrument, the SCPI command level is returned to the root level.

IEEE-488.2 Basic Commands IEEE-488.2 standard defines a set of basic commands to restore default settings, clear event and status registers, set event registers and determine the current operation status. All basic commands are three character commands headed with an asterisk (*). The command key words and the first parameter are separated by a space. A semi colon (;) is used to separate multiple commands, as illustrated below: "*RST; *CLS; *ESE 32; *OPC?"

SCPI Parameter Types The SCPI language defines a number of different data formats to send and receive information.

Value parameters: Commands using value parameters support a number of different decimal notations, including scientific, decimal point and signed notation. Additionally, value parameters can also include units directly after some numerical parameters, i.e., s or ms. If a specific value is required, values will be automatically rounded to suit. The command below uses value parameters:

```
CONFigure:COMParator [<NR3>|,<NR3>]
```

Discrete Parameters: A discrete parameter is used to set up a discrete number of parameters (e.g., NORMal, EARTH, NLIne). Like command key words, either short or long, and upper or lower case letters can be used. Query returns always return short form upper case letters. The command below uses discrete parameters:

```
CONFigure:CURRENT{ACDC | DC | AC | ACPeak}
```

Boolean Parameters: Boolean parameters represent a true or false binary condition. A false condition is represented by, "OFF" or "0" whilst "ON" or "1" is used for a true condition. The instrument will return "0" or "1" from a Boolean query. Below is an example of a command with Boolean parameters.

```
CONFigure:AUTO {OFF|ON}
```

String Parameters: String parameters include almost all the ASCII characters. A character must end and start with a single or double quotation mark.

Quotation delimiters can also be used in a string when quotation marks are used within quotation marks. For example:

```
""quote"" → "quote".
```

Command List

Measurement Network Commands

NETWork {A|B|C|D|E|F|G|H|I} 120
NETWork?

Measuring Equipment Configuration Commands

EQUIPMENT {CLAss1|CLAss2|INTernal} 121
EQUIPMENT?
EQUIPMENT:TYPE {B|BF|CF} 121
EQUIPMENT:TYPE?

Measurement Mode Commands

MODE 122
{EARTh|ENCLosure1|ENCLosure2|ENCLosure3|PATient1|PATient2|PATient3|PAUXiliary}
MODE?

Measurement Commands

CONFigure:AUTO {ON|OFF} 123
CONFigure:AUTO?
CONFigure:FILTer {ON|OFF} 123
CONFigure:FILTer?

Measurement Items

CONFigure:COMParator {[<NR3>[,<NR3>]]}	124
CONFigure:COMParator?	
CONFigure:CURRent {ACDC AC DC ACPeak}	124
CONFigure:CURRent?	
CONFigure:RANGe{AUTO HOLD1 HOLD2 HOLD3 HOLD4}	125
CONFigure:RANGe?	

Manual Measurement Commands

CONFigure:CONDition {NORMal EARTH POWersource NAPPLY RAPPLY LLINE NLINE}	127
CONFigure:CONDition?	
CONFigure:POLarity {NORMal REVerse}	131
CONFigure:POLarity?	

Automatic Measurement Commands

CONFigure:AMITem <NR1>	132
CONFigure:AMITem?	
CONFigure:AMTime <NR1>	133
CONFigure:AMTime?	
CONFigure:AMTime:WAI <NR1>	134
CONFigure:AMTime:WAI?	

Measurement Command

START	134
STOP	134

Measurement Data Commands

MEASure:AUTO? 135

Save Data Commands

MEMory:NUMBer? 136

MEMory:IDENtity? <NR1> 137

MEMory:MEASure? <NR1> 137

MEMory:SAVE:AUTO 139

System Setup Commands

SYStem:BACKlight <NR1> 139

SYStem:BACKlight?

SYStem:BEEPer:COMParator {FAIL|PASS|OFF} 140

SYStem:BEEPer:COMParator?

SYStem:BEEPer:KEY {ON|OFF} 141

SYStem:BEEPer:KEY?

SYStem:BEEPer:T2OUT {ON|OFF} 141

SYStem:BEEPer:T2OUT?

SYStem:BEEPer:T3OUT {ON|OFF} 142

SYStem:BEEPer:T3OUT?

SYStem:CLEar:MEASure 142

SYStem:CLEar:PANel 142

SYStem:DATE <Year>,<Month>,<Day> 143

SYStem:DATE?

SYStem:FILE? <NR1> 143

SYStem:LANGUage {ENGLISH|CHINESE} 147

SYStem:LANGUage?

SYStem:LOAD <NR1>	148
SYStem:SAVE <NR1>	148
SYStem:TEST:VA?	148
SYStem:TIME <Hour>,<Minute>	149
SYStem:TIME?	

System Related Commands

SYStem:ERRor?	149
*IDN?	150
*RST	150
*TST?	150
*WAI	151

RS232 Interface Commands

SYStem:LOCal	151
SYStem:REMote	151

IEEE488.2 Interface Commands

*SRE	157
*SRE?	
*STB?	157
*ESE <NR1>	158
*ESE?	
*ESR?	158
*CLS	159
*OPC	159

Commands

Measurement Network Commands

NETWork

Selects a measurement network or queries the current network type.

Syntax NETWork {A|B|C|D|E|F|G|H|I}

Query Syntax NETWork?

Query Return Returns network type: A|B|C|D|E|F|G|H|I

A: A network

F: F network

B: B network

G: G network

C: C network

H: H network

D: D network

I: I network

E: E network

Example NETWork B

Sets the current network as network B.

Query Example NETWork?

Return: B

Current network is B.

Measuring Equipment Configuration Commands

EQUIPMENT

Sets or queries the EUT class.

Syntax	EQUIPMENT {CLASS1 CLASS2 INTERNAL}	
Query Syntax	EQUIPMENT?	
Query Return	Returns the equipment class of the EUT: CLASS1 CLASS2 INTERNAL	
	CLASS1: CLASS I	INTERNAL: Internally powered
	CLASS2: CLASS II	
Example	EQUIPMENT CLASS1 Sets the class of the EUT to "CLASS I".	
Query Example	EQUIPMENT? Return: CLASS1 Returns the current EUT class.	

EQUIPMENT:TYPE

Sets or queries the applied part of the EUT.

Note: This command can only be used with medical networks.

Syntax	EQUIPMENT:TYPE {B BF CF}	
Query Syntax	EQUIPMENT:TYPE?	
Query Return	Returns the applied part of the EUT: B BF CF (Medical Network only)	
	B: B Type	BF: BF Type
	CF: CF Type	
Example	EQUIPMENT:TYPE BF The the applied part of the EUT is set to type BF for Medical network.	
Query Example	EQUIPMENT:TYPE? Return: BF Type BF is the currently applied part of the EUT for Medical networks.	

Measurement Mode Command

MODE

Set or queries the measurement mode.

Note: Different measuring networks have different measurement modes.

Syntax MODE
 EARTH|ENClosure1 (ENCL1)|ENClosure2(ENCL2)
 |ENClosure3 (ENCL3)|PATient1 (PAT1)|PATient2(PAT2)
 |PATient3 (PAT3)|PAUXiliary(PAUX)

Query Syntax MODE?

Query Return Returns the measurement mode:
 EARTH|ENCLOSURE1|ENCLOSURE2|ENCLOSURE3|P
 ATIENT1|PATIENT2|PATIENT3|PAUXILIARY

When measurement network A,B,C,D,E,G,H or I is selected:

EARTH	Earth leakage current.
ENClosure1	Enclosure to earth leakage current.
ENClosure2	Enclosure to enclosure leakage current.
ENClosure3	Enclosure to line leakage current.

When measurement network F is selected:

EARTH	Earth leakage current
ENClosure1	Enclosure to earth leakage current
ENClosure2	Enclosure to enclosure leakage current
PATient1	Patient leakage current I
PATient2	Patient leakage current II
PATient3	Patient leakage current III
PAUXiliary	Patient Auxiliary Current

Example MODE EARTH
 Sets the measurement mode to Earth leakage current.

Query Example MODE?
 Return: EARTH
 Earth leakage current is the current measurement mode.

Measurement Commands

CONFigure:AUTO

Configures or queries the current measurement mode. When the measurement mode is set to Auto, a measurement can be started after any of the following:

The *Start* key on the panel has been pressed.

The START line of the EXT I/O line is sent low

The START command is used.

Syntax CONFigure:AUTO {ON|OFF}

Query Syntax CONFigure:AUTO?

Query Return Returns the current measurement mode as a string:
 (ON|OFF)

 ON: Automatic mode OFF: Manual mode

Example CONFigure:AUTO OFF

 Sets the measurement mode to manual mode.

Query Example CONFigure:AUTO?

 Return: OFF

 The current measurement mode is manual.

CONFigure:FILTer

Sets or queries whether Network F has the RC network enabled/disabled. If the RC network is OFF, a 1k pure resistance filter is used.

Syntax CONFigure:FILTer {ON|OFF}

Query Syntax CONFigure: FILTer?

Query Return Returns a string indicating if the RC network is ON or OFF.

 ON: RC filter is ON.

	OFF: RC filter is OFF, pure 1k resistance is enabled.
Example	CONFigure:FILTer OFF Turns the RC filter OFF for Measuring Network F.
Query Example	CONFigure:FILTer ? Return: OFF Returns the RC filter status. The RC filter is turned off.

Measurement Items

CONFigure:COMParator

Sets the current measuring mode's upper and lower limit.

Syntax	CONFigure:COMParator {[<NR3>[,<NR3>]]}
Query Syntax	CONFigure:COMParator?
Query Return	Returns the current measuring mode upper and lower limit. The first parameter is the upper limit, the second is the lower limit. <NR3>: Range: +4.000E-6 ~ +20.00E-03 (in Amps)
Example	CONFigure:COMParator +4.000E-03,+100.0E-06 Set the upper limit to 4mA and the lower limit to 100uA.
Query Example	CONFigure:COMParator? Return: +4.000e-03,+1.000E-04 Returns an upper limit of 4mA and a lower limit of 100uA.

CONFigure:CURRent

Sets or queries the leakage current type.

Syntax	CONFigure:CURRent {ACDC AC DC ACPeak}
Query Syntax	CONFigure:CURRent?

Query Return	Returns the leakage current type as a string: ACDC AC DC ACPeak ACDC: AC+DC DC: DC AC: AC ACPeak : AC PEAK
Example	CONFigure:CURRent DC Set the leakage current type to DC.
Query Example	CONFigure:CURRent? Return: DC DC is the leakage current type.

CONFigure:RANGe

Sets or queries the current range.

Note: Leakage current ranges can only be selected when in manual mode.

Syntax	CONFigure:RANGe{AUTO HOLD1 HOLD2 HOLD3 HOLD4}																				
Query Syntax	CONFigure:RANGe?																				
Query Return	Return value: Returns the current range as a string: AUTO HOLD1 HOLD2 HOLD3 HOLD4 When AC, DC, AC+DC leakage current is selected (target): <table> <tr> <td>AUTO</td> <td>Automatic current range</td> </tr> <tr> <td>HOLD1</td> <td>25.00mA range</td> </tr> <tr> <td>HOLD2</td> <td>5.000mA range</td> </tr> <tr> <td>HOLD3</td> <td>500.0uA range</td> </tr> <tr> <td>HOLD4</td> <td>50.00uA range</td> </tr> </table> When ACpeak leakage current is selected: <table> <tr> <td>AUTO</td> <td>Automatic current range</td> </tr> <tr> <td>HOLD1</td> <td>75.0mA file</td> </tr> <tr> <td>HOLD2</td> <td>10.00mA range</td> </tr> <tr> <td>HOLD3</td> <td>1.000mA range</td> </tr> <tr> <td>HOLD4</td> <td>500.0uA range</td> </tr> </table>	AUTO	Automatic current range	HOLD1	25.00mA range	HOLD2	5.000mA range	HOLD3	500.0uA range	HOLD4	50.00uA range	AUTO	Automatic current range	HOLD1	75.0mA file	HOLD2	10.00mA range	HOLD3	1.000mA range	HOLD4	500.0uA range
AUTO	Automatic current range																				
HOLD1	25.00mA range																				
HOLD2	5.000mA range																				
HOLD3	500.0uA range																				
HOLD4	50.00uA range																				
AUTO	Automatic current range																				
HOLD1	75.0mA file																				
HOLD2	10.00mA range																				
HOLD3	1.000mA range																				
HOLD4	500.0uA range																				

Example CONFigure:RANGe AUTO
 Set the leakage current range to AUTO.

Query Example CONFigure:RANGe?
 Return: AUTO
 AUTO is the current leakage current range.

Manual Measurement Commands

CONFigure:CONDition

Sets or queries the EUT status when in manual measurement mode.

Note: The CONFigure:CONDition command or query can only be used in manual measurement mode.

Syntax	CONFigure:CONDition {NORMal EARTH POWersource NAPPLY RAPPLY LLINe NLINe}														
Query Syntax	CONFigure:CONDition?														
Query Return	Returns the EUT status when in manual measurement mode. NORMal EARTH POWersource NAPPLY RAPPLY LLINe NLINe <table> <tr> <td>NORMal</td> <td>Under normal conditions.</td> </tr> <tr> <td>EARTH</td> <td>Disconnected earth line.</td> </tr> <tr> <td>POWersource</td> <td>Disconnected live line.</td> </tr> <tr> <td>NAPPLY</td> <td>Normal connection, positive phase, 110% voltage application.</td> </tr> <tr> <td>RAPPLY</td> <td>Negative phase, 110% voltage application.</td> </tr> <tr> <td>LLINe</td> <td>Application of voltage from the live line. Normal live line connection.</td> </tr> <tr> <td>NLINe</td> <td>Application of voltage from the neutral line. Normal neutral line connection.</td> </tr> </table>	NORMal	Under normal conditions.	EARTH	Disconnected earth line.	POWersource	Disconnected live line.	NAPPLY	Normal connection, positive phase, 110% voltage application.	RAPPLY	Negative phase, 110% voltage application.	LLINe	Application of voltage from the live line. Normal live line connection.	NLINe	Application of voltage from the neutral line. Normal neutral line connection.
NORMal	Under normal conditions.														
EARTH	Disconnected earth line.														
POWersource	Disconnected live line.														
NAPPLY	Normal connection, positive phase, 110% voltage application.														
RAPPLY	Negative phase, 110% voltage application.														
LLINe	Application of voltage from the live line. Normal live line connection.														
NLINe	Application of voltage from the neutral line. Normal neutral line connection.														
Example	CONFigure:CONDition NORMal Set the leakage current test to normal conditions.														
Query Example	CONFigure:CONDition ? Return: NORMAL The leakage current test is set to normal conditions.														

Conditions

Under network A, B, C, D, E, G, H, I

Machine Status		CLASS-I				
		Single Fault condition				
Measurement Mode	Normal	Power line disconnected	Earth disconnected	Live line output	Neutral Line output	
Earth Leakage Current	●	●	--	--	--	
Enclosure to Line leakage current	--	--	--	●	●	
Enclosure and earth leakage current	●	●	●	--	--	
Enclosure to Enclosure leakage current	●	●	●	--	--	

Machine Status		CLASS-II				
		Single Fault Condition				
Measurement Mode	Normal	Power Line Disconnected	Earth Disconnected	Live line output	Neutral Line output	
Earth Leakage Current	--	--	--	--	--	
Enclosure to Line leakage current	--	--	--	●	●	
Enclosure and earth leakage current	●	●	--	--	--	
Enclosure to Enclosure leakage current	●	●	--	--	--	

Machine Status		Int power			
		Single Fault condition			
Measurement Mode	Normal	Power Line Disconnected	Earth Disconnected	Live line output	Neutral Line output
Earth Leakage Current	--	--	--	--	--
Enclosure to Line leakage current	--	--	--	--	--
Enclosure and earth leakage current	●	--	--	--	--
Enclosure to Enclosure leakage current	●	--	--	--	--

Under Network F:

Machine Status		CLASS-I			
		Single Fault condition			
Measurement Mode	Normal	Power Line Disconnected	Earth Disconnected	110% output positive polarity	110% output negative polarity
Earth Leakage Current	●	●	--	--	--
Enclosure and earth leakage current	●	●	●	●	●
Enclosure to Enclosure leakage current	●	●	●	●	●
Patient Auxiliary current	●	●	●	--	--
Patient Leakage Current I	●	●	●	--	--
Patient Leakage Current II	--	--	--	●	●
Patient Leakage Current III	--	--	--	●	●

Machine Status		CLASS-II			
		Single Fault Condition			
Measurement Mode	Normal	Power Line Disconnected	Earth Disconnected	110% output positive polarity	110% output negative polarity
Earth Leakage Current	--	--	--	--	--
Enclosure and earth leakage current	•	•	--	•	•
Enclosure to Enclosure leakage current	•	•	--	•	•
Patient Auxiliary current	•	•	--	--	--
Patient Leakage Current I	•	•	--	--	--
Patient Leakage Current II	--	--	--	•	•
Patient Leakage Current III	--	--	--	•	•

Machine Status		Int power			
		Single Fault Condition			
Measurement Mode	Normal	Power Line Disconnected	Earth Disconnected	110% output positive polarity	110% output negative polarity
Earth Leakage Current	--	--	--	--	--
Enclosure and earth leakage current	●	--	--	●	●
Enclosure to Enclosure leakage current	●	--	--	●	●
Patient Auxiliary current	●	--	--	--	--
Patient Leakage Current I	●	--	--	--	--
Patient Leakage Current II	--	--	--	●	●
Patient Leakage Current III	--	--	--	●	●

●Selectable, -- Not selectable

CONFigure:POLarity

Sets or queries the power supply polarity in manual testing.

Note: The power supply polarity can only be set in manual measurement/mode.

Syntax	CONFigure:POLarity {NORMAL REVerse}
Query Syntax	CONFigure:POLarity?
Query Return	Return value: Returns the polarity of the power supply in manual measurement NORMAL REVerse NORMAL positive polarity REVerse negative polarity

Example CONFigure:POLarity NORMal
 Sets the power supply to positive polarity.

Query Example CONFigure:POLarity?
 Return: NORMal
 The polarity of the power supply is currently set to positive.

Automatic Measurement Commands

CONFigure:AMITem

Configure or query all auto measurement settings. The settings must be compatible with the measuring network, class and leakage mode, refer to the list from the page 128. Any bits that are set to 1 indicate that the corresponding mode/function is set.

Note: Automatic measurements cannot be made in manual measurement mode.

Syntax CONFigure: AMITem <NR1>

Query Syntax CONFigure:AMITem?

Query Return <NR1> Returns a 9-bit integer (1~512).

256	128	64	32	16	8	4	2	1
Bit8	bit7	bit6	bit5	bit4	bit3	bit2	bit1	bit0
NLINE	LLINE	Neg phase	Pos phase	RAPPLY	NAPPLY	EARTH	POWER-source	NORMAL
		NORMAL		Under normal conditions.				
		POWERsource		Disconnected live line.				
		EARTH		Disconnected earth line.				
		NAPPLY		Normal connection, positive phase, 110% voltage application.				
		RAPPLY		Negative phase, 110% voltage application.				
		LLINE		Application of voltage from the live line. Normal live line connection.				

NLINE Application of voltage from the neutral line. Normal neutral line connection.

Example		CONFigure: AMITem <101>						
256	128	64	32	16	8	4	2	1
Bit8	bit7	bit6	bit5	bit4	bit3	bit2	bit1	bit0
0	0	1	1	0	0	1	0	1

Automatic measurement items include: normal power supply, disconnected earth line, normal polarity, and reverse polarity.

Query Example CONFigure: AMITem?
 Return: 4
 Power source disconnected is the current measurement setting.

CONFigure:AMTime

Set or query the auto measurement duration, ranging from 1~300 seconds.

Note: Auto measurement configuration cannot be used in manual mode.

Syntax CONFigure:AMTime <NR1>

Query Syntax CONFigure:AMTime?

Query Return Returns the auto measurement time value.
 <NR1> 1~300 secs.

Example CONFigure:AMTime 2
 Set the duration of the auto measurement to 2 secs.

Query Example CONFigure:AMTime?
 2
 Returns the auto measurement time (2 seconds).

CONFigure:AMTime:WAI

Sets or queries the wait time in automatic mode. Range: 1~1800 seconds.

Note: The wait time can only be set in automatic mode. The wait time cannot be changed when in manual mode.

Syntax	CONFigure:AMTime:WAI <NR1>
Query Syntax	CONFigure:AMTime:WAI?
Query Return	Returns the wait time value under auto mode. <NR1> 1~1800 seconds.
Example	CONFigure:AMTime:WAI 8 When in automatic mode, sets the wait time to 8 seconds.
Query Example	CONFigure:AMTime:WAI? Return: 8 Returns the wait time for automatic mode.

Measurement CommandSTART

Starts the measurement.

Syntax START

Example START
Starts the measurement.

STOP

Stops the measurement.

Syntax STOP

Example STOP
Stops the measurement.

Measurement Data Command

MEASure:AUTO

Queries the maximum value after auto measurement.

Note: This command can only be used for automatic testing.

Query Syntax MEASure:AUTO?

Query Return Returns the file name and 5 values < value1>, <value2>, < value3>, <value4>, < value5>.

<value1>	The maximum value in Amps
<value2>	Power supply polarity: 0: Positive polarity 1: Negative polarity
<value3>	Equipment status: 0: Normal conditions 1: Disconnected live line. 2: Disconnected earth line. 3: Normal neutral line connection conditions, 110% voltage application. 4: Negative phase, 110% voltage application. 5: Normal live line connection conditions. Application of voltage from the live line. 6: Normal neutral line connection conditions. Application of voltage from the neutral line.
<value4>	Leakage current type: 0: AC 1: DC 2: AC+DC 3: ACpeak

<value5> Judgment Value:
 0: Measurement is within upper and lower judgment limits (PASS)
 1: Measurement is greater than the upper limit (FAIL-U)
 2: Measurement is less than the lower limit (FAIL-L)

Query Example MEASure:AUTO?
 File_01
 +1.031E-03,0,0,1,0,+1.024E-03,1,0,1,0
 +1.040E-03,0,1,1,1,+1.019E-03,1,1,1,0
 +1.013E-03,0,2,1,2,+1.027E-03,1,2,1,0

Return value examples are shown in the table below:

Maximum	Power polarity	Equipment Status	Leakage current type	Judgment
1.031mA	Positive	Normal	DC	PASS
1.024mA	Negative	Normal	DC	PASS
1.040mA	Positive	Power line disconnected	DC	FAIL-U
1.019mA	Negative	Power line disconnected	DC	PASS
1.013mA	Positive	Earth disconnected	DC	FAIL-L
1.027mA	Negative	Earth disconnected	DC	PASS

Save Data Command

MEMory:NUMBer

Query the data where the file no. is recorded and saved.

Query Syntax MEMory:NUMBer?

Query Return Returns the number of data files, ranging from 1~100.

Query Example MEMory:NUMBer?
 Return: 7
 A total of 7 measurement records have been saved.

MEMory:IDENtity

Queries the assigned file's name and time it was last updated.

Query Syntax MEMory:IDENtity? <NR1>
 <NR1> Memory number, range: 1~100.

Query Return Returns three strings <char value1>, <char value2>,
 <char value3>
 <char value1> File name.
 <char value2> File number
 <char value3> Time of the last update.

Query Example MEMory:IDENtity? 6
 Return: CeL,NO-6, 2008/08/08.
 Where CeL is the name of the file. 6 is the file number
 and 2008/8/8 is the update time.

MEMory:MEASure

Reads saved data.

Query Syntax MEMory:MEASure? <NR1>
 <NR1> Memory number, range 1~100.

Query Return Returns the file name and 5 values < value1>,
 <value2>, < value3>, <value4>, < value5>.
 <value1> Maximum, in Amps
 <value2> Power supply polarity:
 0: Positive polarity
 1: Negative polarity
 <value3> Equipment status:
 0: Normal conditions
 1: Disconnected live line.
 2: Disconnected earth line.

3: Normal neutral line connection conditions, 110% voltage application.

4: Negative phase, 110% voltage application.

5: Normal live line connection conditions. Application of voltage from the live line.

6: Normal neutral line connection conditions. Application of voltage from the neutral line.

<value4>

Leakage current type:

0: AC

1: DC

2: AC+DC

3: ACpeak

<value5>

Judgment Value:

0: Measurement is within upper and lower judgment limits (PASS)

1: Measurement is greater than the upper limit (FAIL-U)

2: Measurement is less than the lower limit (FAIL-L)

Query Example MEASure:AUTO?6

file_01

+1.031E-03,0,0,1,0,+1.024E-03,1,0,1,0

+1.040E-03,0,1,1,1,+1.019E-03,1,1,1,0

+1.013E-03,0,2,1,2,+1.027E-03,1,2,1,0

Return value examples are shown in the table below:

Maximum	Power polarity	Equipment Status	Leakage current type	Judgment
1.031mA	Positive	Normal	DC	PASS
1.024mA	Negative	Normal	DC	PASS

1.040mA	Positive	Power line disconnected	DC	FAIL-U
1.019mA	Negative	Power line disconnected	DC	PASS
1.013mA	Positive	Earth disconnected	DC	FAIL-L
1.027mA	Negative	Earth disconnected	DC	PASS

Note If there's no return value for the file no. query, 0 will be returned.

MEMory:SAVE:AUTO

Saves auto measurement results, including file name, file no., instrumentation class, medical network application, network, measurement mode, measurement type, leakage current, leakage current range, maximum limit, minimum limit, measuring conditions, power supply polarity and auto measurement items.

Syntax MEMory:SAVE:AUTO

Example MEMory:SAVE:AUTO

Saves auto measurement results.

System Setup Command

SYStem:BACKlight

Sets or queries the backlight to turn off automatically after a set time.

Syntax SYStem:BACKlight

<NR1> Range: 0~30

Query Syntax SYStem:BACKlight?

Query Return Returns the wait time (in minutes) before the backlight will automatically turn off.

0 Infinite (backlight will not automatically turn off).

1~30 Time in minutes before the backlight will turn off.

- Example** `SYStem:BACKlight 2`
 Sets the backlight to turn off after two minutes.
- Query Example** `SYStem:BACKlight?`
 Return: 2
 Backlight automatic off-time is 2 minutes.
- Note** `SYStem:BACKlight 0`
 The above command will turn the backlight back on.

`SYStem:BEEPer:COMParator`

Sets or queries the alarm tone for judgment events.

- Syntax** `SYStem:BEEPer:COMParator {FAIL|PASS|OFF}`
- Query Syntax** `SYStem:BEEPer:COMParator?`
- Query Return** Returns a string indicating which event produces an alarm tone.
- FAIL** The alarm tone will sound when a measurement is outside the upper and/or lower judgment limits (FAIL)
- PASS** The alarm tone will sound when a measurement is within the upper and/or lower judgment limits (PASS)
- OFF** The alarm tone is set to off.

- Example** `SYStem:BEEPer:COMParator PASS`
 Sets the alarm tone to sound when a measurement passes.

- Query Example** `SYStem:BEEPer:COMParator?`
 Return: PASS
 The the alarm tone is set to on for a PASS measurement.

SYStem:BEEPer:KEY

Sets or queries whether a tone is set for key entry (button presses).

Syntax SYStem:BEEPer:KEY {ON|OFF}

Query Syntax SYStem:BEEPer:KEY?

Query Return Returns a string to indicate if a tone will sound when a key is pressed.

ON A tone will sound when a key is pressed

OFF No tone will sound for key presses.

Example SYStem:BEEPer:KEY OFF

Turns off the tone sound for key entry.

Query Example SYStem:BEEPer:KEY?

Return: OFF

The tone sound for key entry is set to off.

SYStem:BEEPer:T2OUT

Sets or queries the tone sound of the T2 output.

Syntax SYStem:BEEPer:T2OUT {ON|OFF}

Query Syntax SYStem:BEEPer:T2OUT?

Query Return Returns the beeper status (on or off when voltage is output from T2).

ON The beeper is set to on when voltage is output from T2.

OFF The beeper is set to off when voltage is output from T2.

Example SYStem:BEEPer:T2OUT ON

The beeper is set to on.

Query Example SYStem:BEEPer:T2OUT?

Return: ON

Beeper is on.

SYStem:BEEPer:T3OUT

Sets or queries the tone sound of the T3 output when the voltage output is at 110%.

Syntax	SYStem:BEEPer:T3OUT {ON OFF}
Query Syntax	SYStem:BEEPer:T3OUT?
Query Return	Returns the beeper status (on or off when the T3 output is at 110%).
	ON The beeper is set to on when the T3 voltage output is at 110%.
	OFF The beeper is set to off when the T3 voltage output is at 110%.
Example	SYStem:BEEPer:T3OUT ON Turn on the beeper when the T3 voltage output is at 110%.
Query Example	SYStem:BEEPer:T3OUT? Return: ON The beeper is on.

SYStem:CLEAr:MEASure

Clears all the saved measurement data.

Note: All the saved values will be deleted after this command is executed.

Syntax	SYStem:CLEAr:MEASure
Example	SYStem:CLEAr:MEASure Clears all the saved measurement data.

SYStem:CLEAr:PANel

Clears all the panel settings that are saved.

Note: This command will clear all saved panel settings.

Syntax	SYStem:CLEAr:PANel
Example	SYStem:CLEAr:PANel All the panel contents are cleared after executing the command.

SYStem:DATE

Sets or queries the system date.

Syntax SYStem:DATE <Year>,<Month>,<Day>

Query Syntax SYStem:DATE?

Query Return Returns the system date:<Year>,<Month>,<Day>.

Year 2000~2050(<NR1>)

Month 1~12(<NR1>)

Day 1~31(<NR1>)

Example SYStem:DATE 2009,08,26

Sets the system date to November 26, 2009

Query Example SYStem:DATE?

2009,08,26

Returns the year, month and day.

SYStem:FILE

Queries all the contents of a measurement file.

Query Syntax SYStem:FILE? <NR1>

<NR1> File number, ranging from 1~30.

Query Return 16 character/number strings are returned:

<char value1> File name

<char value2> File number

<char value3> Instrument class level:

CLA1: CLASS I

CLA2: CLASS II

INT: Internally powered

<char value4> Medical network (application type):

B: Type B

BF: Type BF

CF: Type CF

<char value5> Network (Circuit network):

	A: Network A
	B: Network B
	C: Network C
	D: Network D
	E: Network E
	F: Network F
	G: Network G
	H: Network H
	I: Network I
<Num value1>	Measurement mode: 0: Earth leakage current 1: Enclosure to earth leakage current 2: Enclosure and enclosure leakage current 3: Enclosure and line leakage current 4: Patient leakage current I 5: Patient leakage current II 6: Patient leakage current III 7: Patient auxiliary current
<Num value2>	Measurement method: 0: manual measurement 1: automatic measurement
<Num value3>	Leakage current type: 0: AC 1: DC 2: AC+DC 3: ACpeak
<Num value4>	Measurement range: When the leakage current type is

AC, DC or AC+DC:

0: Automatic range

1: 25.00mA range

2: 5.000mA range

3: 500.0uA range

4: 50.00uA range

When the leakage current type is
AC Peak:

0: Automatic range

1: 75.0mA range

2: 10.0mA range

3: 1.000mA range

4: 500.0uA range

- <Num value5> Upper pass limit
- <Num value6> Lower pass limit
- <Num value7> Measurement conditions:
- 0: normal conditions
- 1: Disconnected live line
- 2: Disconnected earth line
- 3: Normal neutral line connection conditions. 110% voltage application.
- 4: Negative phase. 110% voltage application.
- 5: Normal live line connection conditions. Application of voltage from the live line.
- 6: Normal neutral line connection conditions. Application of voltage from the neutral line.
- <Num value8> Power supply polarity:
- 0: Positive polarity
- 1: Negative polarity

<Num value9> Auto Measurement test items, range 1~512:

256	128	64	32	16	8	4	2	1
Bit8	bit7	bit6	bit5	bit4	bit3	bit2	bit1	bit0
NLINE	LLINE	Neg phase	Pos phase	RAPPLY	NAPPLY	EARTH	POWersource	NORMAL

<Num value10> Auto measurement measuring time in seconds {NR1}

<Num value11> Auto measurement wait time in seconds {NR1}

Note: Measurement conditions and Power supply polarity (<num value7&8>) are returned when a manual measurement is set.

<num value9> ~ <num value11> are the return values when an automatic measurement is set.

0 is returned when there is no data.

Query Example

SYSTEM:FILE? 6

Return:

Panel06,NO-6,CLA2,B,F,1,0,1,2,+2.500E-02,+0.400E-02,0,0,123,1,1

The 6th file has the following configuration:

File name	Panel06
File No.	NO-6
Equipment class	CLASS-II
Network (medical)	B
Network,(circuit)	F network
Measurement mode	Enclosure - earth leakage
Measurement method	automatic
Leakage current type	DC
Leakage current range	10.00mA

Upper limit level	25mA
Lower limit level	4mA
Measurement conditions	NONE
Power supply polarity	NONE
Automatic measurement test items	Neg phase, Pos phase, RApPly, NApPly, POWersource, NORMal
Automatic measurement measurement time	1s
Automatic measurement wait time	1s

SYStem:LANGUage

Sets or queries the system user interface language.

Syntax SYStem:LANGUage {ENGLISH|CHINese}

Query Syntax SYStem:LANGUage?

Query Return Returns the current system language as a string:
ENGLISH|CHINese

ENGLISH Current instrument display language is English

CHINese Current instrument display language is Chinese

Example SYStem:LANGUage CHINese
Set the instrument language to Chinese.

Query Example SYStem:LANGUage?
CHINese
Returns the language (Chinese).

SYStem:LOAD

Load panel settings from memory.

Syntax SYStem:LOAD <NR1>
 <NR1> Range: 1~80

Example SYStem:LOAD 6
 Loads the panel settings from file no. 6.

SYStem:SAVE

Save panel settings to memory.

Syntax SYStem:SAVE <NR1>
 <NR1> Range: 1~30.

Example SYStem:SAVE 3
 Saves the panel settings to file no. 3.

SYStem:TEST:VA

Performs a VA check of a device under test.

Query Syntax SYStem:TEST:VA?

Query Return Returns 5 Numbered values:
 <num value1> The voltage between the live and
 neutral lines (NR3).
 <num value2> The current (NR3).
 <num value3> The VA value (voltage X
 current)(NR3).
 <num value4> The voltage between the live and
 neutral lines.
 <num value5> The voltage between the live and
 earth lines.

Query Example SYStem:TEST:VA?
 +3.869E+01, +1.294E+01, +5.008E+02, +3.319E+01,
 +3.319E+01

The result is described as below:

The voltage between a live line and neutral line:
 +3.869E+01

Current: +1.294E+01

VA value: +5.008E+02

The voltage between a live line and earth contact:
 +3.319E+01

The voltage between a neutral and earth contact:
 +3.319E+01

SYStem:TIME

Sets or queries the current system time.

Syntax SYStem:TIME <Hour>,<Minutes>

Query Syntax SYStem:TIME?

Query Return Returns the the system time <Hour>,<Minutes>.

Hour 24 hours

Minutes minutes

Example SYStem:TIME 15, 30

Set the system time to 3:30.

Query Example SYStem:TIME?

Return: 15:30 (System time is 15:30).

System Related Commands

SYStem:ERRor

Read system error messages. Up to 20 error messages are stored at a time, with a maximum of 80 characters per message. Error messages are read in a FIFO manner.

Query Syntax SYStem:ERRor?

Query Return Returns a character string of up to 80 characters.

Query Example SYStem:ERRor?
 Return: -101 Invalid character (Invalid character error message)

***IDN?**

Shows the instrument identification.

Query Syntax *bIDN?

Query Return Returns a string that includes four comma separated fields: instrument manufacturer, model, serial number and version.

Query Example *bIDN?
 Return: GW Instek,GLC9000,123456,V0.62
 GW Instek: Manufacturer
 GLC9000: Model
 123456: Model serial number
 V0.62: Firmware version number

***RST**

Restores the initial instrument settings.

Syntax *bRST

***TST?**

Queries the self-test and RAM test.

Query Syntax *bTST?

Query Return Return Value:
 0: Indicates no errors
 2: RAM errors

Query Example *bTST?
 Return: 0
 No error
 Return: 2
 RAM error

*WAI

Waits for the current operation to complete.

Syntax *WAI

RS232 Interface Command

SYStem:LOCaI

Sets the leakage current tester to local mode.

Syntax SYStem:LOCaI

SYStem:REMOte

Sets the leakage current meter to RS232 remote control mode. In this mode front panel operation is locked.

Syntax SYStem:REMOte

SCPI Status Registers

All SCPI instruments have the same basic status register groups. The status registers consist of 3 registers: The Status Byte register, the Standard Event Register and the Questionable Data Register.

The Status Byte Register summarizes the other register groups. Below is a block diagram of the Status Register groups.

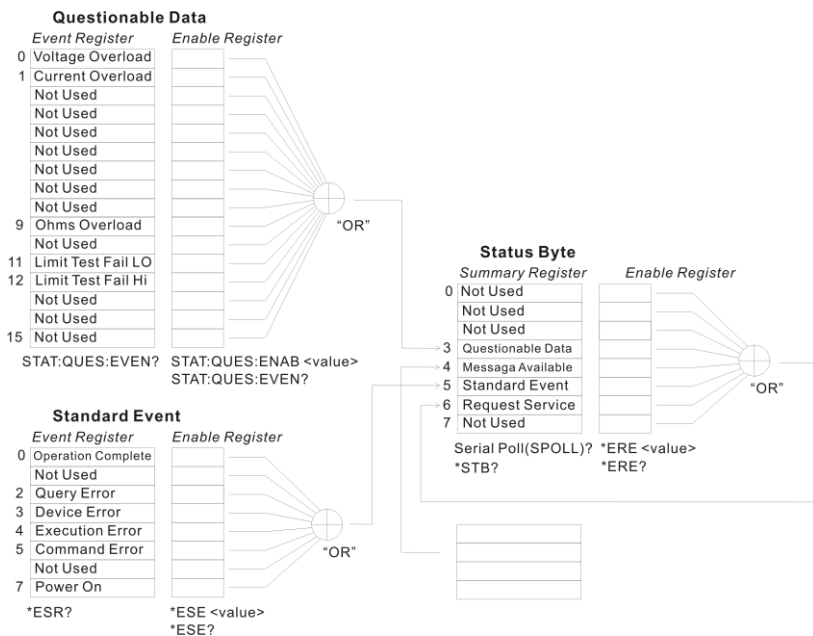

Event Registers

The Standard Event and Questionable data register groups have event registers. The Event registers are read only and are used to determine the status of the instrument. If any bit in the event registers are set to 1, it means that the corresponding event has occurred. The event registers will only be cleared when the power is turned on or if a *CLS or *ESR command is used.

Restoring the default settings or using the *RST will not clear the event registers.

Querying the event registers will return the value of the weighted sum of all the binary bits.

Enable Registers

Setting any bit to 1 in the Enable Registers, allows the corresponding bit to be enabled in the Event Registers. The Enable Registers are logically summed to form a summary of the (enabled) events in the Questionable Data and Standard Event registers.

Querying the Enable registers will not clear the registers, however the *CLS command will clear any enabled bits in the event registers.

Status Byte Register

The Status Byte Register contains the summary of the Status Registers, the status of the output queue and the input buffer as well as the generation of service requests. Any data in the output buffer will set the “Message Available bit” (MAV bit, bit 4). Conversely reading the output buffer will clear the MAV bit.

Clearing any event register will also clear the corresponding bit in the status byte register. A SRQ (Service request) is generated by executing the *SRE command with a bit weight.

Bit Summary- Status Byte Register

Bit Position	Bit Weight	Description
0 Unused	1	Unused, returns “0”
1 Unused	2	Unused, returns “0”
2 Error Queue	4	This bit is set if there is data in the Error Queue
3 Questionable data	8	Summary of the Questionable Data Register
4 Message available	16	Shows that the output queue contains at least one message.
5 Standard Event Summary	32	Summary of the Standard Event Status Register.
6 Request Service	64	The Request Service Register is the logical sum of all the enabled bits of the Status Byte Register, excluding its own.
7 Unused	128	Unused, returns “0”

Under the following situations, the status byte register will be cleared:

- Using the *CLS command.
- Reading the Standard Event Register

Under the following conditions the Status Byte Enable Register will be cleared:

- Using the *SRE 0 command.

Using the STB? Query:

- If bits 2-5 of the Status Byte Register are set to 0, using the *STB? query will clear the Request Service Bit (bit 6).

Using the *OPC command:

To see if a command has completed, the *OPC command or query (OPC?) can be used. The OPC command will set bit “0” of the Standard Event Register to 1 when the operation proceeding the OPC command has completed. In contrast, the OPC query will not set bit “0” of the Standard Event Register, instead, it will return “1”.

A query error occurs if the return value makes the output queue exceed the output queue size. A command error occurs if data follows a command.

Standard Event Register

The Standard Event Register groups report when any of the following events occur: power on, command syntax errors, command execution errors, self-test or calibration errors, query errors and when the *OPC command is issued. Any event that has its corresponding bit enabled in the Standard Event Status Enable register is logically summed to set the Standard Event Summary bit in the Status Byte Register. The *ESE command can be used to set the bit weight of the Standard Event Status Enable Register.

Bit Summary - Standard Event Register

Bit Position	Bit Weight	Bit Weight
0 Operation Complete	1	The Operation Complete bit is set when the *OPC command is executed and all standby operations have finished.
1 Unused	2	Unused, returns "0"
2 Query Error	4	The Query Error bit is set when: There is an attempt to read the Output Queue when empty. When data is lost from the output queue. When the output queue overflows.
3 Device Error	8	Indicates there is a self-test, calibration or device-specific error.
4 Execution Error	16	Indicates that an execution error has occurred.
5 Command Error	32	Indicates that a command syntax error has occurred.
6 Unused	64	Unused, returns "0"
7 Power On	128	Power on. When the machine is turned on this, bit is set.

The Standard Event Register can be cleared under the following:

- Using the *CLS command
- Using the *ESR? Query to query the event register

The Standard Event Status Enable Register can be cleared by:

- Using the *ESE 0 command

Status Byte Register Command

*SRE

Sets the bit weight of the service request enable register. The SRER determines which events in the Status Byte Register are allowed to set the Service Request bit. Any bit that is set to "1" will cause the Service Request bit to be set.

Syntax *SRE <NR1>

Query Syntax *SRE?

Query Return Returns the bit weight of the service request enable register.

<NR1> 0~255

Example *SRE 7

Sets the SRER to 0000111.

Query Example *SRE?

Return: 7

Returns 7, the bit weight of the SRER, binary 00000111.

*STB?

Queries the Status Byte Register, including the service request bit. The STB? query will clear all the bits in the status byte register excluding the MSS bit.

Query Syntax *STB?

Query Return Returns the bit weight of Status Byte register.

<NR1> 0~255

Query Example *STB?
 Return: 81
 Returns 81, the bit weight of the STB, binary 0101 0001.

Standard Event Register Commands

*ESE

Sets or queries the Standard Event Status Enable Register.

Syntax *ESE <NR1>

Query Syntax *ESE?

Query Return Returns the bit weight of the SESER.
 <NR1> 0~255

Example *ESE 65
 Sets the SESER to 65, binary 0100 0001.

Query Example *ESE?
 Return: 65
 Returns 65, the bit weight of the SESER, binary 0100 0001.

*ESR?

Queries the Event Status Register.

Query Syntax *ESR?

Query Return Returns the bit weight of the Event Status Register.
 <NR1> 0~255

Example *ESE 65
 Sets the SESER to 65, binary 0100 0001.

Query Example *ESR?
 Return: 198
 Returns 98, the contents of the ESER, binary 1100 0110.

Other Status Register Commands

*CLS

Clears the Status Byte register and all the event registers.

Syntax *CLS

Example *CLS

Clears all the event registers.

*OPC

Sets the OPC bit of the Standard Event Status Register after all outstanding commands have completed. When queried, will return "1" after any outstanding commands are complete.

Syntax *OPC

Query Syntax *OPC?

Query Return Returns "1" to the output buffer after all outstanding commands have completed.

- Error Messages
- With First In First Out (FIFO) errors, the first error returned is the first error saved. When an error message is read, the error will be cleared. An alarm tone will sound for each error by default.
 - If the number of errors is more than 20, the last error saved in the queue will be replaced with a Queue overflow error. No more queue errors will be saved until the queue is cleared.
 - The error queue can be cleared by using *CLS (Clear Status) or by powering the instrument down. When the error queue is read, the associated error message is cleared. Using the *RST command will not clear the error queue.
 - Remote Control Operation

SYSTEM:ERRor?

An error message is read from the Error Queue.

Error messages can have up to 255 characters. For example: -113,"Undefined header"

Errors

Command Errors

-101 Invalid character

An invalid character such as \$, #, % was used in the command header, or parameter. For example: NETWork B #.

-102 Syntax error

An invalid syntax was used in the command string.

SYStem: DATE?

-103 Invalid separator

An invalid or unexpected separator was used in the command string. For example: a comma was used instead a colon, MEMory,NUMBer?

-108 Parameter not allowed

More parameters were received than expected. For example:

CONFigure:AUTO? 10

-109 Missing parameter

Fewer parameters were received than expected. For example: MEMory:READ:IDENTity?

-112 Program Mnemonic Too Long

Program header exceeds the character limit (12).

For example:

CONFigure:COMPARARORDSA:DC?

-113 Undefined header

An invalid command header. The command may be invalid or incorrect. Short form commands can only have 4 letters. For example: SYStE:FILE?

-123 Exponent Too Large

Exponent parameter greater than 32,000. For example: `CONFigure:COMParator 1E33000`

-128 Numeric data not allowed

Indicates that a numeric value was received but the system does not accept one in that position. For example, `SYSTem: DATE 2008,tt,30`

-131 Invalid suffix

Indicates the suffix does not follow the expected syntax or is inappropriate. For example: `CONFigure:MTIME 1min`

-138 Suffix not allowed

Indicates a suffix was encountered when that command doesn't allow suffixes. For example: `SYSTem:TIME 12,34sec`

-148 Character data not allowed

Character data was encountered where a different parameter type was expected. Check that an invalid parameter is not used. For example: `EQUIPMENT OFF`

-158 String data not allowed

String data was encountered where a different parameter type was expected. Check that an invalid parameter is not used. For example: `SYSTem:BEEPer:KEY open`

-170 Expression error

This error is generated when a command doesn't expect expressions. For example: `CONFigure:MTIME 1.0E+2`

Execution Errors

-221 Setting conflict

Indicates that a legal command was received, but cannot be executed in the current machine state.

-222 Data out of range

Indicates that the parameter is out of range. For example: CONFigure:MTIME 2000

Device Specific Errors

-350 Queue Overflow

The Queue Overflow error occurs when the number of error messages is greater than 20 (error queue is full). When the error queue is full, the error queue will be cleared and the Queue Overflow message will be generated. The Queue overflow error can be cleared by using the *CLS command or resetting the instrument. Note: Using the *RST command will not clear the Queue overflow error message.

EXTERNAL I/O

Features

1. Remote Start/Stop control
2. Recall the last 30 panel settings
3. Output measurement results.
4. Output measurement timing signals
5. Enable internal or external power

Cautions



CAUTION

1. To prevent damage, ensure the power is off before connecting the instrument.
2. Ensure the input voltage or current doesn't exceed the EXT I/O rating.
3. When using a relay, ensure that a protective diode is used to limit surge current.
4. Do not short the input or output terminals.
5. Don't short live and earth lines.
6. Only attempt to operate the instrument after the external I/O port is properly connected.

I/O Definition

Apart from power, all external control signals are active low.

Pin No.	Input/ Output	Signal Name	Description
1	Input	$\overline{\text{KEYLOCK}}$	The key lock is active on a low level signal.
2	Input	$\overline{\text{STOP}}$	Stop the current measurement
3	Input	$\overline{\text{LOAD1}}$	Selects a panel setting to load. LOAD1 is bit 2 of 5
4	Input	$\overline{\text{LOAD3}}$	Selects a panel setting to load. LOAD3 is bit 4 of 5
5	Input	$\overline{\text{TEST}}$	Active when testing
6	---	Reserved	
7	Output	$\overline{\text{PASS}}$	Active on a PASS judgement
8	Output	$\overline{\text{L-FAIL}}$	Active on a FAIL judgement (under lower limit)
9	---	Reserved	
10	Output	5VDC	Internal power supply
11	Output	5VDC	
12	Output	GND-INT	Internal ground
13	Output	GND-INT	
14	Input	$\overline{\text{START}}$	Start the Automatic measurement. Measurement will start when Load0 to LOAD4 are set and START is set to low (active low). The corresponding panel is also read.
15	Input	$\overline{\text{LOAD0}}$	Selects a panel setting to load. LOAD0 is bit 1 of 5

16	Input	$\overline{\text{LOAD2}}$	Selects a panel setting to load. LOAD2 is bit 3 of 5
17	Input	$\overline{\text{LOAD4}}$	Selects a panel setting to load. LOAD5 is bit 5 of 5
18	---	Reserved	
19	Output	$\overline{\text{MEAS}}$	The MEAS signal goes low for each measurement item during automatic measurement.
20	Output	$\overline{\text{H-FAIL}}$	Active on a FAIL judgement (exceeding upper limit)
21	---	Reserved	
22	Input	VDC-EXT	Power supply input from external equipment: 5~24V DC
23	Input	VDC-EXT	
24	Input	GND-EXT	Ground input from external equipment
25	Input	GND-EXT	

LOAD0~LOAD4 control table and corresponding panel settings

Panel no.	$\overline{\text{LOAD4}}$	$\overline{\text{LOAD3}}$	$\overline{\text{LOAD2}}$	$\overline{\text{LOAD1}}$	$\overline{\text{LOAD0}}$
1	1	1	1	1	0
2	1	1	1	0	1
3	1	1	1	0	0
4	1	1	0	1	1
5	1	1	0	1	0
6	1	1	0	0	1
7	1	1	0	0	0
8	1	0	1	1	1
9	1	0	1	1	0
10	1	0	1	0	1
11	1	0	1	0	0
12	1	0	0	1	1
13	1	0	0	1	0

14	1	0	0	0	1
15	1	0	0	0	0
16	0	1	1	1	1
17	0	1	1	1	0
18	0	1	1	0	1
19	0	1	1	0	0
20	0	1	0	1	1
21	0	1	0	1	0
22	0	1	0	0	1
23	0	1	0	0	0
24	0	0	1	1	1
25	0	0	1	1	0
26	0	0	1	0	1
27	0	0	1	0	0
28	0	0	0	1	1
29	0	0	0	1	0
30	0	0	0	0	1

Connection

1. Connect the EXT I/O cable to the EXT I/O terminal on the rear panel.
2. Power on the machine.
3. A remote icon is displayed on the LCD screen when remote connection is established. The KEYLOCK line will be active.
4. Complete all measurements before turning off the instrument.
5. Remove external EXT I/O connections.

Electrical Characteristics

Input Signals

$\overline{\text{KEYLOCK}}$, $\overline{\text{START}}$, $\overline{\text{STOP}}$, $\overline{\text{LOAD0}}$ ~ $\overline{\text{LOAD4}}$

Input Signal	Active Low
Maximum input voltage	24V DC (EXT-DCV), 5VDC (INT-DCV)
High Level	Up to EXT-DCV
Low Level	0.3VDC or less

Output signal

$\overline{\text{TEST}}$, $\overline{\text{MEAS}}$, $\overline{\text{PASS}}$, $\overline{\text{L-FAIL}}$, $\overline{\text{H-FAIL}}$

Output Signal	Open collector
Maximum Output voltage	24V DC (EXT-DCV), 5VDC (INT-DCV)
Minimum Output Current	50mA DC

Internal Power Supply

INT-DCV, INT-GND

Output Voltage	5V DC
Maximum output current	100mA (A large current output may damage the power supply)
Note	To enable internal power; connect INT-DCV and EXT-DCV, INT-GND and EXT-GND.

Internal Circuit Configuration

Prior to using the EXT I/O connection please carefully read the electrical characteristics above and refer to the internal electrical circuit structure below. Ensure EXT-GND and EXT-DCV is connected to drive the circuit I/O. The optocoupler outputs are open-collector outputs with a maximum current of 50mA.

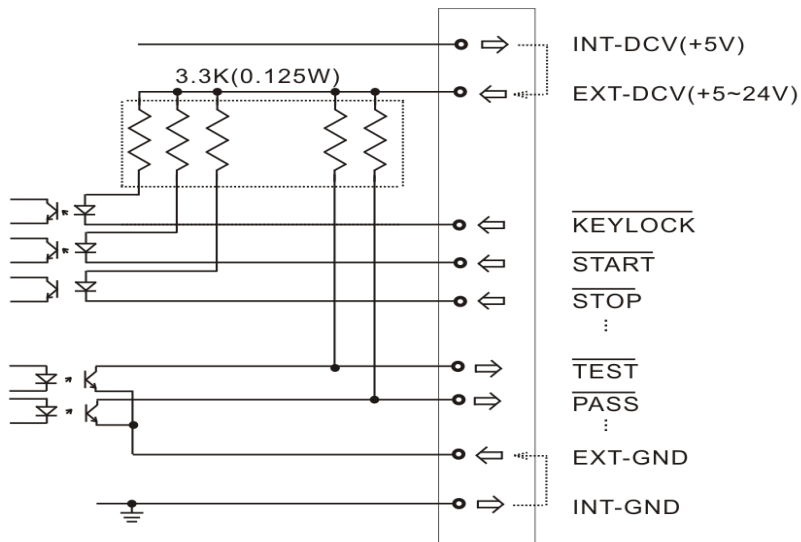

Timing Description

When the $\overline{\text{KEYLOCK}}$ signal is low, the external control (EXT-I/O) signal can be enabled, after which a panel setting ($\overline{\text{LOAD0}} \sim \overline{\text{LOAD4}}$) can be loaded and the $\overline{\text{START}}$ signal can then be pulsed low to start automatic measurement. The timing chart of the output signals is shown below:

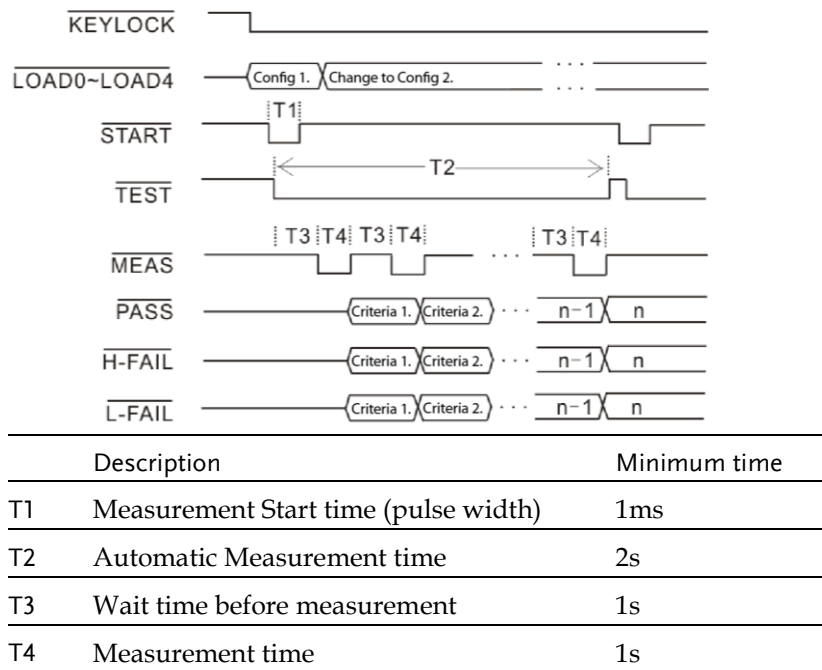

F AQ

Q1. Machine will not turn on.

A1. Ensure the instrument is correctly connected to the mains terminal and that the fuse has not blown.

Q2. The alarm isn't working.

A2. Perform a machine Sound self-test, or check *Beep* inside the *System* menu.

Q3. No voltage is output to the EUT.

A3. Check to see the circuit breaker.

Q4. The LCD touch panel is not working correctly.

A4. The touch panel may need to be recalibrated. Press the *System* key then choose *LCD* to calibrate the touch screen.

For more information, please contact your nearest distributor or contact GW Instek at:

www.gwinstek.com or marketing@goodwill.com.tw

A PPENDIX

Measurement Functions

Leakage Current Measurement Modes	Earth leakage current Enclosure to earth leakage current Enclosure to enclosure leakage current Enclosure and line leakage current Patient Auxiliary current Patient Leakage current I Patient Leakage current II Patient Leakage current III
Leakage Current Type	DC, AC, AC+DC, ACpeak
Maximum allowable measurement current	25mA (rms), 75mA (AC peak)
Leakage Current Range	25mA (Max 25.00mA, Resolution 0.01mA) 5mA (Max 5.000mA, Resolution:0.001mA) 500uA (Max 500.0uA, Resolution:0.1uA) 50uA (Max 50.00uA, Resolution:0.01uA)
Range Switch	AUTO, HOLD
110% Voltage Application	T3 output, internal 12k resistance protection

Measurement Terminals	Terminals T1, T2 (32mA fuse protected), T3
--------------------------	--

Measuring Networks	MD:A, B, C, D, E, F, G, H, I
-----------------------	------------------------------

Specifications

Specification accuracy is only applicable when the GLC-9000 has been warmed up for 30 minutes and has an operating temperature of +18°C - +28°C. The specifications below are based on a 1kΩ purely resistive network. For networks G and H scale the range by 1/1.5 and ½ respectively.

DC

Ranges	Range	Resolution	Accuracy
25.00mA	5.00mA ~ 25.00mA	10uA	±(0.2%rdg+3dgt)
5.000mA	0.500mA ~ 5.000mA	1uA	±(0.2%rdg+3dgt)
500.0uA	50.0uA ~ 500.0uA	0.1uA	±1.0%fs
50.00uA	4.00uA ~ 50.00uA	0.01uA	±1.0%fs

AC/ AC+DC

Ranges	Range	Resolution	Accuracy	
			10Hz ≦ f ≦ 100kHz	100kHz < f ≦ 1MHz
25.00mA	5.00mA ~ 25.00mA	10uA	±(2.0%rdg+6dgt)	±(2.0%rdg+10dgt)
5.000mA	0.500mA ~ 5.000mA	1uA	±(2.0%rdg+6dgt)	±(2.0%rdg+10dgt)
500.0uA	50.0uA ~ 500.0uA	0.1uA	±(2.0%rdg+6dgt)	±(2.0%rdg+10dgt)
50.00uA	4.00uA ~ 50.00uA	0.01uA	±2.0%fs	±2.0%fs

AC Peak

Ranges	Range	Resolution	Accuracy	
			20Hz ≦ f ≦ 1kHz	1kHz < f ≦ 10kHz
75.0mA	10.0mA ~ 75.0mA	100uA	±(2.0%rdg+2dgt)	±(5.0%rdg+10dgt)
10.00mA	1.00mA ~ 10.00mA	10uA	±(2.0%rdg+2dgt)	±(5.0%rdg+10dgt)
1.000mA	0.500mA ~ 1.000mA	1uA	±2.5%fs	±5.0%fs
500.0uA	40.00uA ~ 500.0uA	0.1uA	±4.0%fs	±5.0%fs

EUT Voltage / Current

Ranges	Range	Resolution	Accuracy
300V	85V ~ 300V	0.1V	±(2%rdg+10dgt)
10A	0.5A ~ 10A	0.1A	±(2%rdg+5dgt)

Voltage

Ranges	Range	Resolution	Accuracy
AC	10.0~300.0V	0.1V	±(3%rdg+2V)
DC	10.0~300.0V	0.1V	±(3%rdg+2V)
AC+DC	10.0~300.0V	0.1V	±(3%rdg+2V)
AC Peck	15.0~430.0V	0.1V	±(3%rdg+2V)

Insulation Resistance

Between chassis and terminals	20MΩ or above (DC 500V)
Between chassis and AC line	30MΩ or above (DC 500V)

Operating Environment

Indoor use
Altitude: ≤2000 meters
Ambient Temperature: 0~40°C
Relative humidity: ≤80%
Installation category II
Pollution degree 2

Storage Environment

Temperature: -10~70°C
Relative humidity: ≤70%

Power Supply

local	AC 100V/120V/220V/230V±10%, 50/60Hz
EUT	AC 85V~250V, 50/60Hz

Dimensions

330 (W) x 150 (H) x 350 (D) mm

Weight

Approximately 5kg

Accessories

Standard Accessories

Name	Type	Quantity	Comments
Quick start guide		1	
CD (User manual)		1	
Test Lead	GTL-117	2 sets	
Alligator clips		4 sets	2 Red, 2 black per set
Foil Probe		1 piece	
Power cord		2	

Optional Accessories

Name	Type	Quantity	Comments
USB cable	GTL-246	1 piece	USB 2.0, A-B type

Measurement Network (MD)

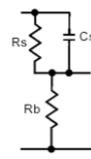
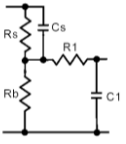
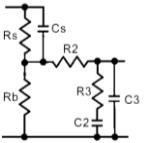
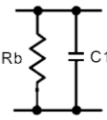
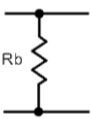
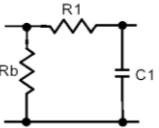
MD	Circuit	R.C. parameters*	Standards Compliance	
A		Rs: 1.5kΩ Rb: 0.5kΩ	Cs: 0.22μF	GB/T12113 IEC60990 GB4943 IEC60995 UL3101 JIS C1010-1
B		Rs: 1.5kΩ Rb: 0.5kΩ R1: 10kΩ	Cs: 0.22μF C1: 0.022μF	GB/T12113 IEC60990 GB4943 IEC60995 UL3101 JIS C1010-1
C		Rs: 1.5kΩ Rb: 0.5kΩ R2: 10kΩ R3: 20kΩ	Cs: 0.22μF C2: 6.2nF C3: 9.1nF	GB/T12113 IEC60990 GB4943 IEC60995 UL3101 JIS C1010-1
D		Rb: 0.5kΩ	C1: 0.45μF	IEC60335-1 UL1563
E		Rb: 1kΩ		UL3101 JIS C9250-92
F		Rb: 1kΩ R1: 10kΩ	C1: 15nF	IEC60601-1 UL2601-1 EN60601-1 UL3111 JIS T1001-92

F Without RC filter Rb: 1kΩ

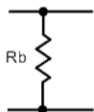

IEC60601-1
UL2601-1
EN60601-1
UL3111
JIS T1001-92

G

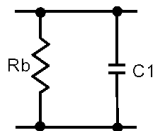

Rb: 1.5kΩ C1: 0.15μF

IEC6075
UL554NP
UL1310
UL471
JIS C9335-1:98
JIS C6065:98

H

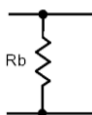

Rb: 2kΩ

IEC60601-1
UL2601-1
EN60601-1
UL1419
UL3111

I

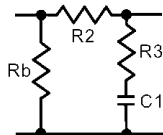

Rb: 1kΩ C1: 11.22nF
R2: 10kΩ
R3: 579Ω

IEC6075
UL554NP
UL1310
UL471
JIS B8561-93

*R 0.1% accuracy C 1% accuracy

Fuse Replacement

- Power Supply Fuse
1. Take out the power cord and remove the fuse socket using a screw driver.

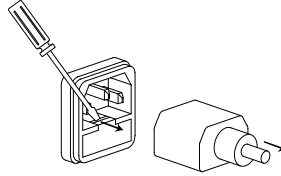

2. Replace the fuse in the holder.

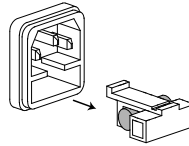

Rating 100V/120V/220V/230V :T0.4A/250V

- T2 Fuse
1. Turn off the power supply and circuit breakers. Remove the test leads

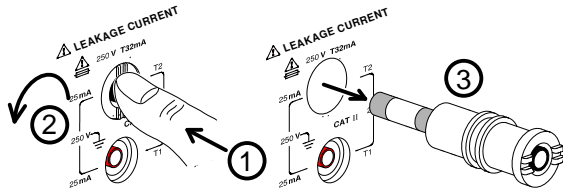

2. Gently push the fuse holder and turn 90 degrees counter clockwise. Remove the fuse.
3. Replace with the appropriate fuse.
4. Insert the fuse holder back into the terminal and turn clockwise 90 degrees.

Rating T32mA/250V

Battery Replacement

Battery Replacement

1. Turn off the machine power and circuit breaker, remove all test leads.
2. Carefully remove the plastic handle caps.

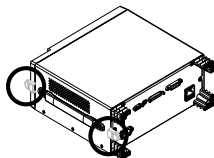

3. Remove the handle and take out the four screws attaching the feet from the rear panel. Remove any other screws holding the case to the base.

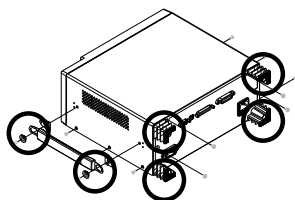

4. Remove the cover. The battery will be revealed.

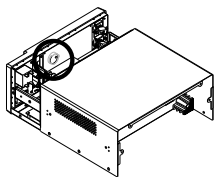

5. Replace the battery as shown below.

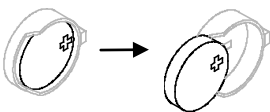

6. Reassemble the instrument in the reverse order of the disassembly.

Declaration of Conformity

We

GOOD WILL INSTRUMENT CO., LTD.

(1) No.7-1, Jhongsing Rd., Tucheng Dist., New Taipei City, Taiwan

(2) No. 69, Lu San Road, Newarea, Suzhou, Jiangsu , China

declare, that the below mentioned product

Type of Product: Leak current tester

Model Number: GLC-9000

are herewith confirmed to comply with the requirements set out in the Council Directive on the Approximation of the Law of Member States relating to Electromagnetic Compatibility (2004/108/EC) and Low Voltage Directive (2006/95/EC).

For the evaluation regarding the Electromagnetic Compatibility and Low Voltage Directive, the following standards were applied:

© **EMC**

EN 61326-1: 2006 Electrical equipment for measurement, control and laboratory use -- EMC requirements	
Conducted Emission	Electrostatic Discharge
Radiated Emission	IEC 61000-4-2:
EN 55011: 2007 + A2: 2007	1995 + A1:1998 + A2:2000
Current Harmonics	Radiated Immunity
EN 61000-3-2: 2006	IEC 61000-4-3: 2006
Voltage Fluctuations	Electrical Fast Transients
EN 61000-3-3:	IEC 61000-4-4: 2004
1995 +A1 :2001+ A2:2005	
-----	Surge Immunity
	IEC 61000-4-5: 2005
-----	Conducted Susceptibility
	IEC 61000-4-6: 2006
-----	Power Frequency Magnetic Field
	IEC 61000-4-8: 2001
-----	Voltage Dip/ Interruption
	IEC 61000-4-11: 2004

© **Safety**

Low Voltage Equipment Directive 2006/95/EC
Safety Requirements
IEC/EN 61010-1: 2001

INDEX

A

Accessories	176
Appendix	173
Auto mode	
selection	69

B

Basic Theory	22
Battery replacement	180
Block Diagram	22

C

Caution symbol	7
Circuit breaker	32
Cleaning the instrument	9
COM setting, remote control	109
Command list	116
Command parameters	114
Command syntax	112
Command tree	112
Copy files to USB	87
Current	
selection	72

D

Declaration of conformity	181
Disposal Instructions	10
Disposal symbol	7

E

Earth leakage current	
definition	24
Earth leakage current	

operation	44
Earth symbol	7
EN61010	
declaration of conformity	181
measurement category	8
pollution degree	9
EN61326-1	181
Enable register	153
Enclosure and earth leakage current	
definition	25
Enclosure and enclosure leakage	
current	
definition	26
Enclosure and enclosure leakage	
current	
operation	48
Enclosure and line leakage current	
operation	50
Enclosure leakage current	
operation	46
Environment	
operation	9
storage	9
Errors	160
EUT power terminal	32
Event register	153
EXT I/O connector	33

F

FAQ	171
firmware update	88
Front panel	31
Fuse	
rating (power)	179
rating (T2)	179
replacement (power)	179
replacement (T2)	179
safety instruction	8

socket overview	34	selection	68
G		Measurement principals	
GBIP connector	33	overview	15
Getting Started	37	Measuring devices	
Grounding class		overview	16
selection	63	Measuring Devices	177
I		Measuring mode	
I/O		selection	67
cautions	163	Measuring network	
characteristics.....	167	selection	64
circuit configuration	168	Measuring terminals.....	32
features	163	O	
pinout	164	Operation	
timing chart	169	date and time	93
Interface		EUT current check.....	98
description.....	59	EUT outlet settings	107
K		EUT voltage check.....	98
Key features.....	19	firmware update.....	88
L		language settings	94
LCD display.....	31	recall settings	80
Leakage current modes		save settings	77
table.....	29	screen capture.....	89
Leakage current modes		self test	95
definition	24	serial number	107
overview.....	14	system initialization	104
M		system settings	91
Main display	59	tone settings	92
Manual mode		touch screen settings.....	96
selection	69	USB connection	85
MD	177	voltage measurement	101
MD standards.....	16	Operation keys	61
Measurement		Overview	13
save.....	75	P	
Measurement flow chart	30	Patient leakage current 1	
Measurement functions	173	connection	53
Measurement methods		Patient leakage current 2	
overview.....	16	operation	55
Measurement networks.....	177	Patient leakage current 3	
Measurement parameters		operation	56
		Patient leakage current I	
		definition	26
		Patient leakage current II	
		definition	27
		Patient Leakage Current III	
		definition	28
		Power and probe connection.....	38

Power supply		Standard event register	156
socket overview.....	34	Start button	31
Power switch	31	Status byte register.....	154
Power up	41		
Preparation	37	T	
Programming commands.....	120		
		T1 terminals	32
R		T2 terminals	32
		T3 terminal	32
Range		Terminal determination table	
selection.....	73	operation	43
Recall settings	80	Touch screen basics	35
remote control			
interface	109	U	
Reset button.....	31		
RS232 terminal.....	33	UK power cord.....	11
		USB B port.....	33
S		USB connection.....	85
		USB host port.....	32
Save settings	77	USB navigation.....	87
SCPI registers.....	152		
Service operation		W	
about disassembly	8		
Shut down	42	Warning indicator.....	32
Single fault conditions		Warning symbol	7
overview	16		
Specifications	175		